

**Elgersburg Lectures – March 2010**

**Lecture IV**

**SYSTEM INTERCONNECTION**

# Outline

- ▶ **Motivation**
- ▶ **Modeling by tearing, zooming, and linking**
- ▶ **An example**
- ▶ **Control as interconnection**
- ▶ **Pole assignment and stabilization**

## Theme

**How are systems interconnected?**

**How are interconnected systems modeled?**

**How does control fit in?**

## Theme

How are systems **interconnected** ?

How are interconnected systems modeled?

How does control fit in?

We deal with very simple examples,  
mainly electrical circuits and  
1-dimensional mechanical systems.

Other applications: hydraulic systems  
chemical systems  
thermal systems, ...

# Systems



OIL REFINERY (GVG / PD)

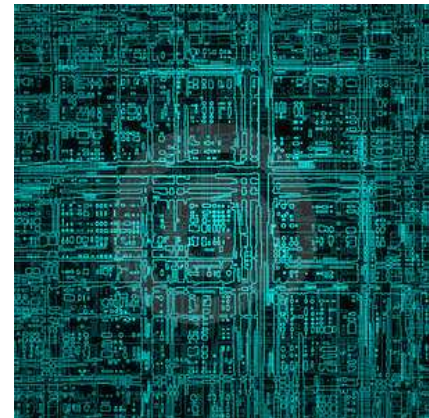
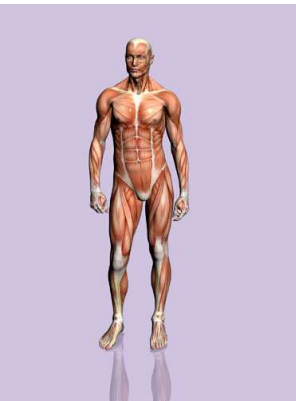
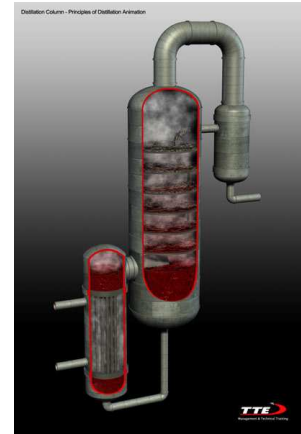

# Features

- ▶ **Open**
- ▶ **Interconnected**
- ▶ **Modular**
- ▶ **Dynamic**

**The ever-increasing computing power allows to model such complex interconnected systems accurately by tearing, zooming, and linking.**

~> **Simulation, model based design, ...**

## Open systems

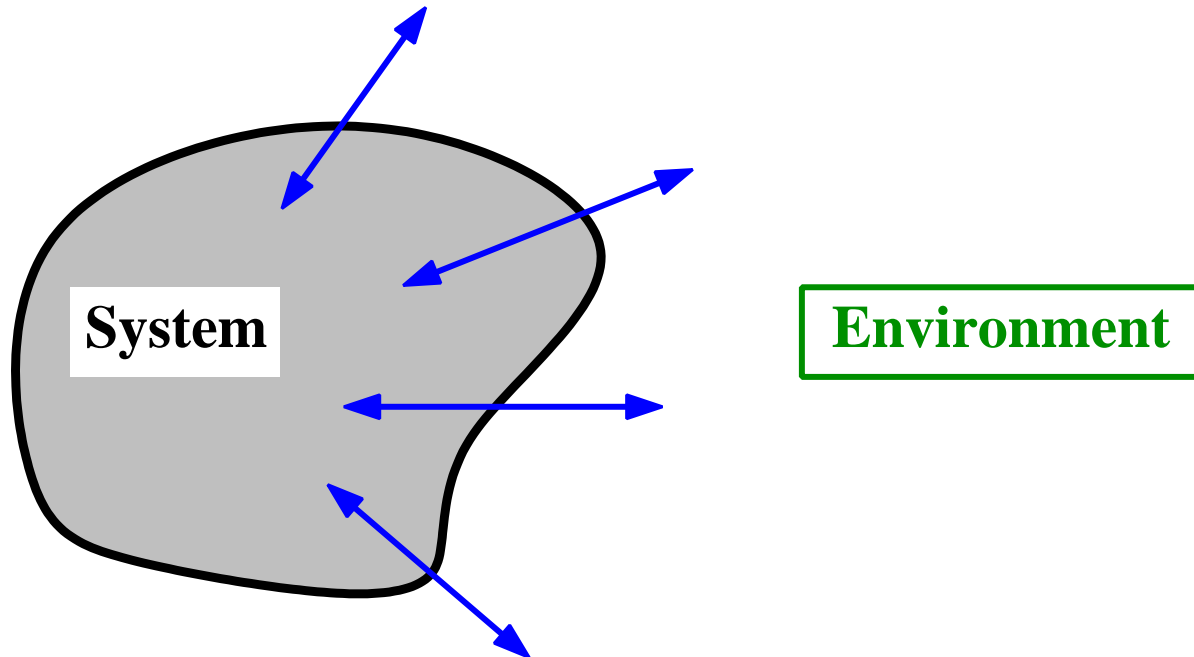

**Systems are ‘open’, they interact with their environment.**

**In the previous lectures, we have seen that thinking of systems in terms of their **behavior** captures the ‘open’ nature of systems very well.**



# Interacting systems

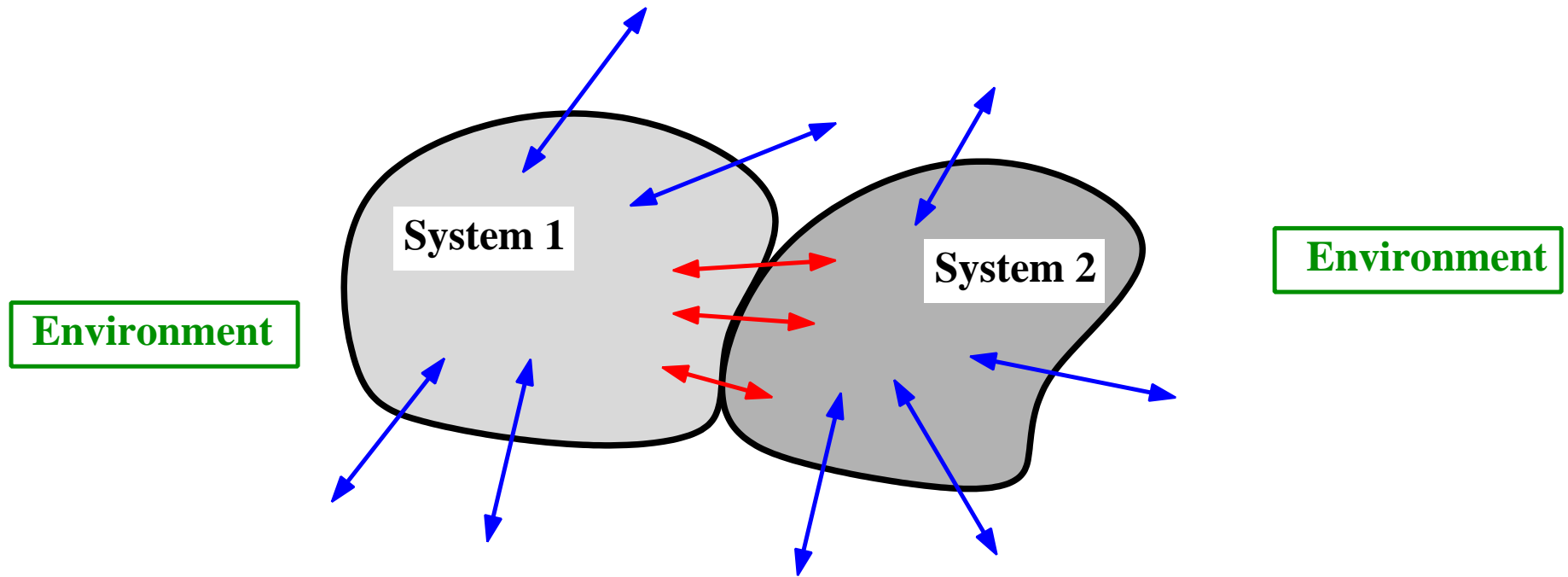

**Interconnected systems interact.**

**How is interaction formalized?**

## Motivation

The ever-increasing computing power allows to model complex interconnected systems **accurately**.

Requires the **right mathematical concepts**

- ▶ for dynamical system (the behavior),
- ▶ for interconnection (this lecture),
- ▶ for interconnection architecture (this lecture).

# Classical view

# Input/output systems

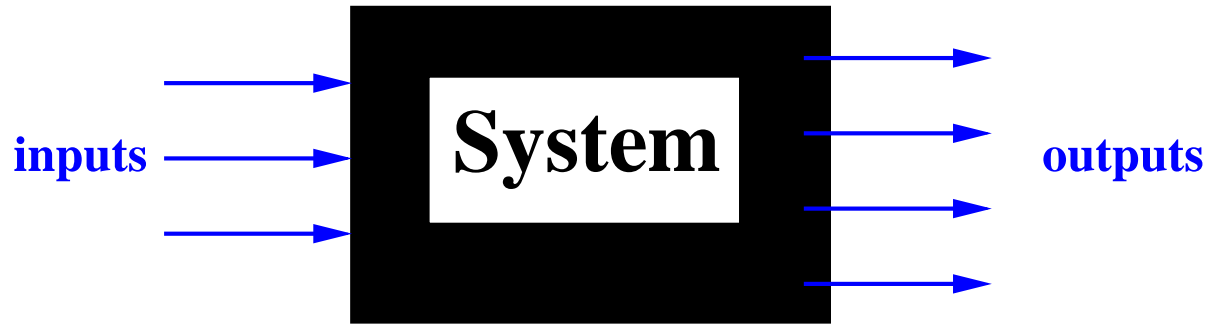

**Oliver Heaviside**  
(1850-1925)

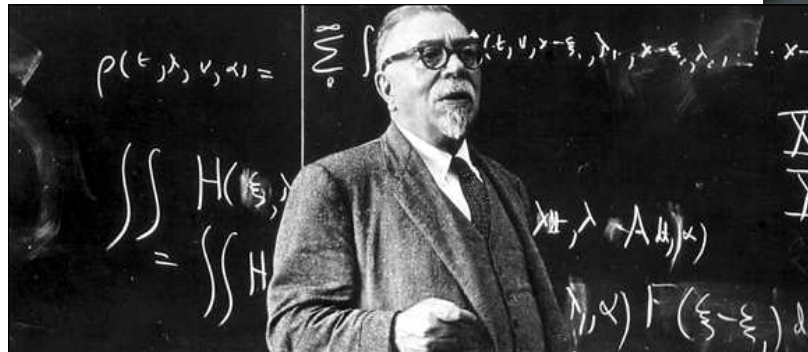

**Norbert Wiener**  
(1894-1964)



**Rudy Kalman**  
(1930- )

## Input/output systems

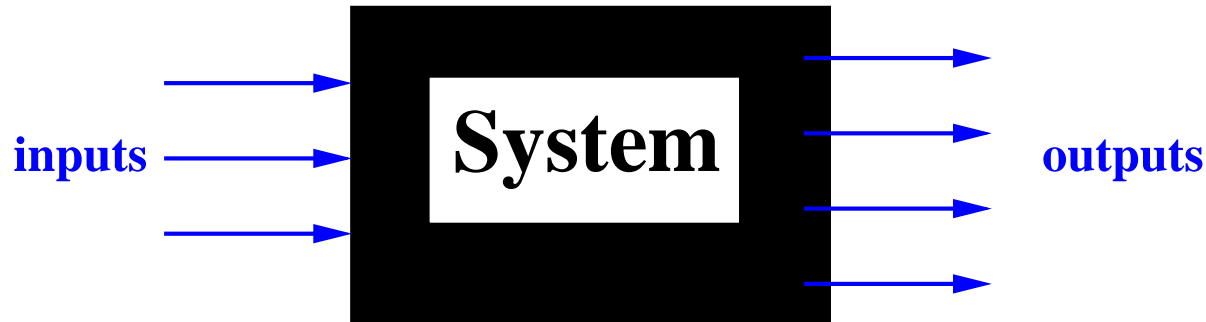

Input/output thinking is *inappropriate* for describing the functioning of physical systems.

**A physical system is not a signal processor.**

Better concept: the behavior.

# Signal flow graphs

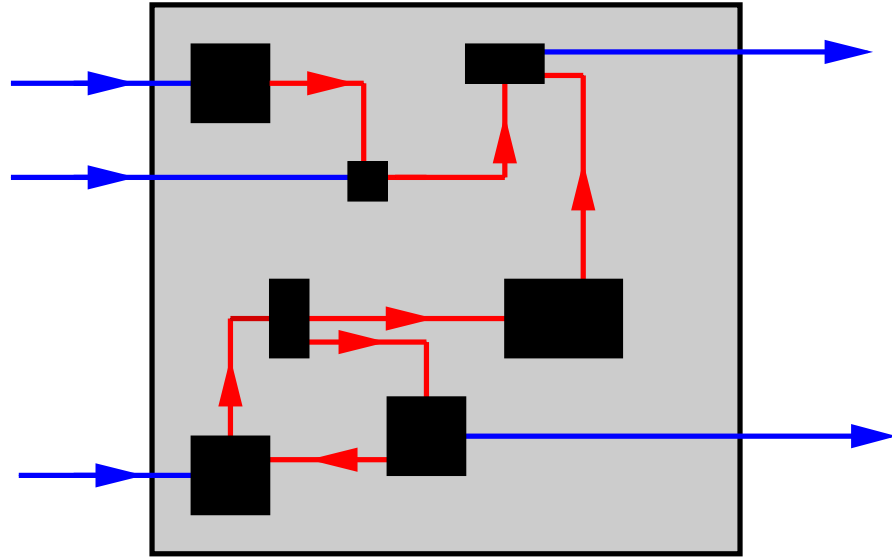

## Signal flow graphs

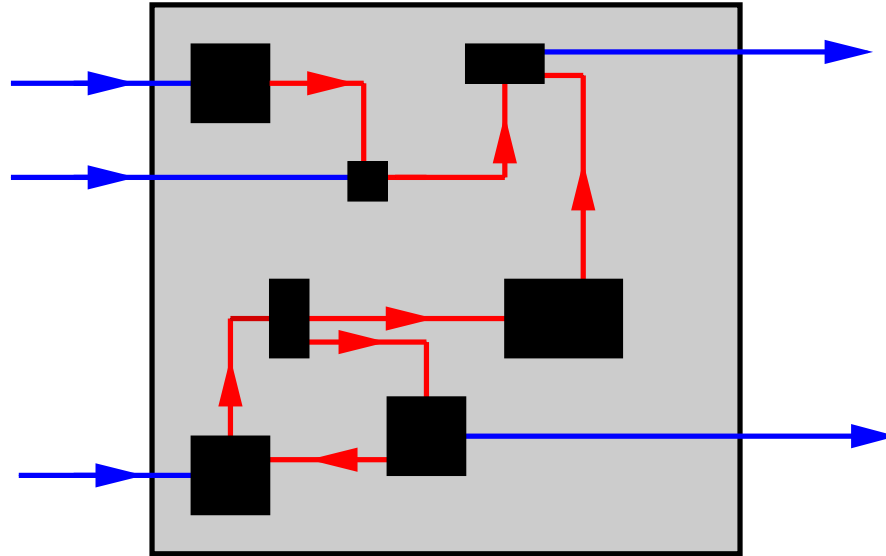

Signal flow graphs are *inappropriate* for describing the interaction architecture of physical systems.

**A physical system is not a signal processor.**

Better concept: graph with leaves.

# Interconnection

Interconnection as output-to-input assignment.

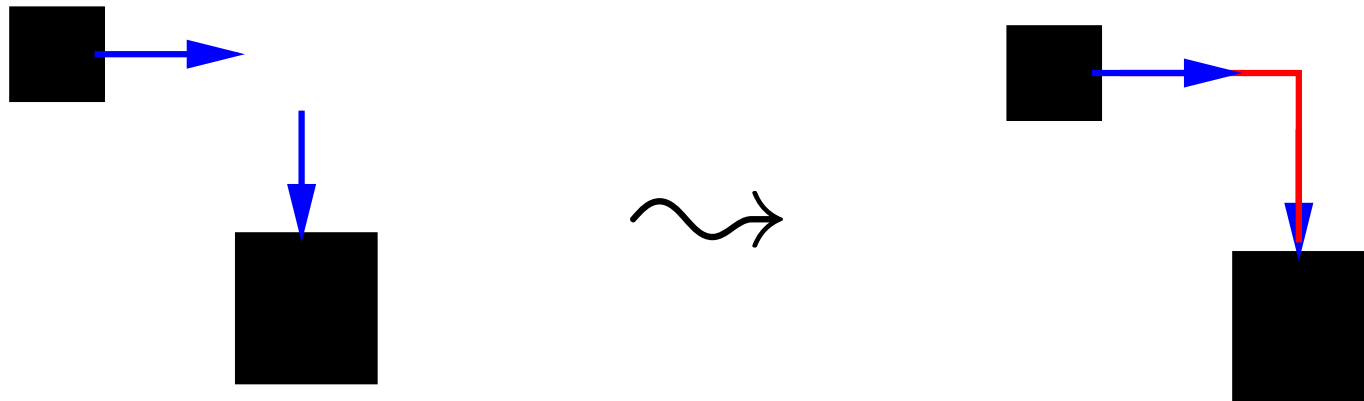



# Interconnection

Interconnection as output-to-input assignment.

Examples:

series

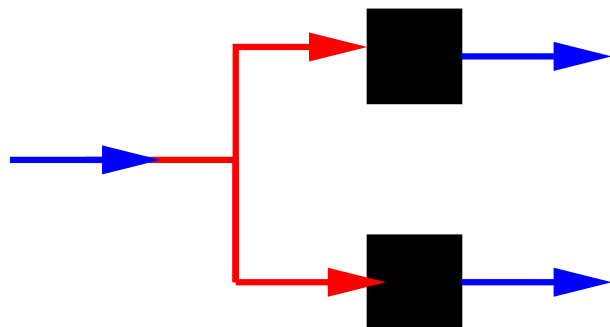
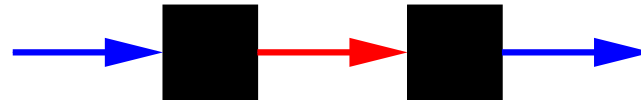

parallel

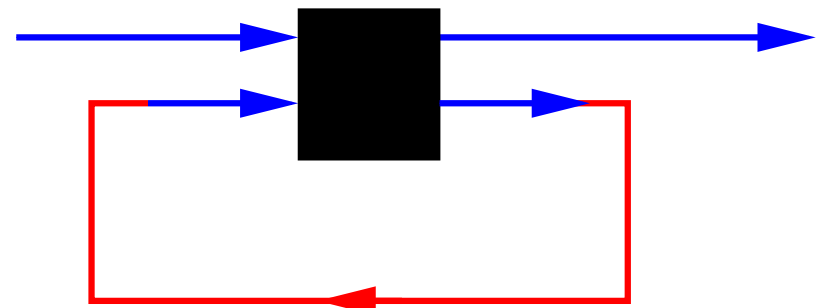

feedback

## Interconnection

Interconnection as output-to-input assignment.

Output-to-input assignment is *inappropriate* for describing the interconnection of physical systems.

A physical system is not a signal processor.

Better concept: variable sharing.

# Examples

# Electrical circuit

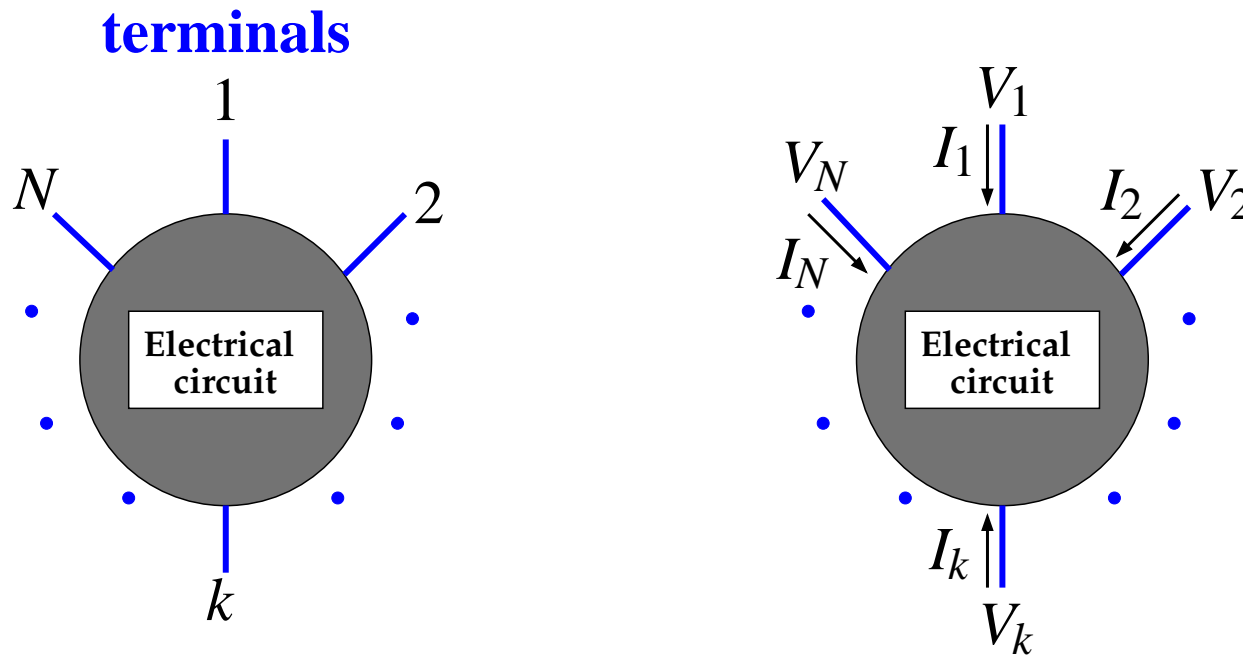

At each terminal:

a **potential (!)** and a **current** (counted  $> 0$  into the circuit),

The relation between potentials of the terminals and voltages across the terminals is discussed in Exercise IV.3.

# Electrical circuit

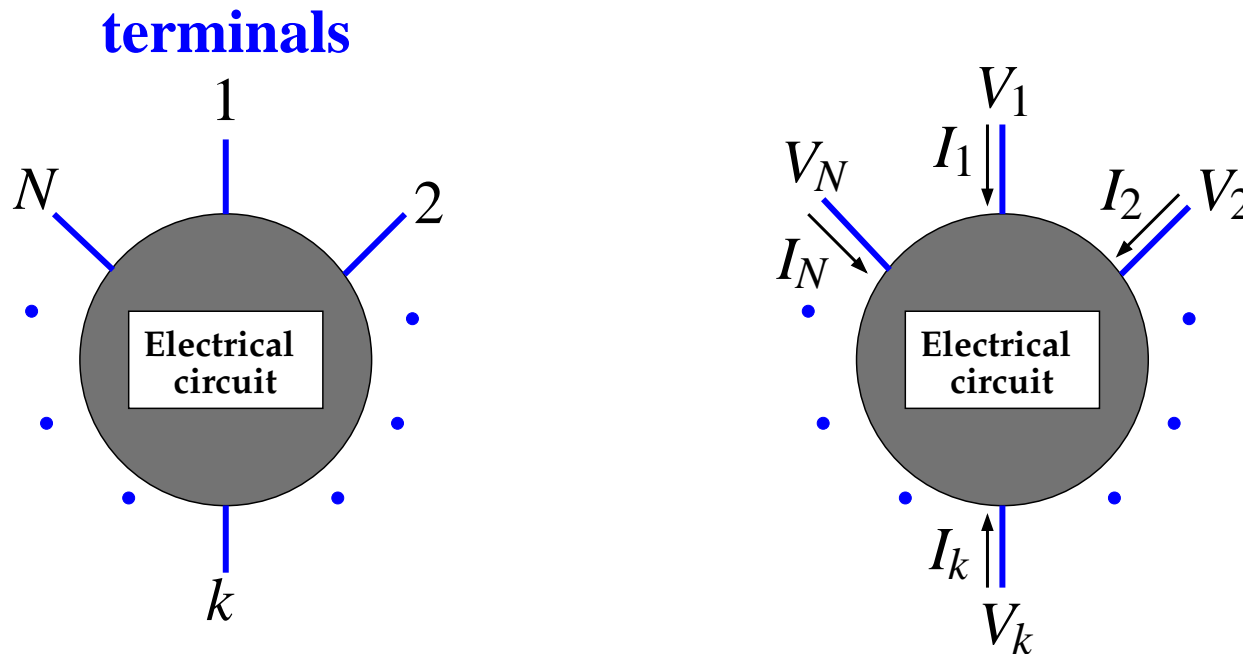

At each terminal:

a **potential (!)** and a **current** (counted  $> 0$  into the circuit),

$\rightsquigarrow$  **behavior**  $\mathcal{B} \subseteq (\mathbb{R}^N \times \mathbb{R}^N)^{\mathbb{R}}$ .

$(V_1, V_2, \dots, V_N, I_1, I_2, \dots, I_N) \in \mathcal{B}$  means:

**this potential/current trajectory is compatible with the circuit architecture and its element values.**

# Mechanical device

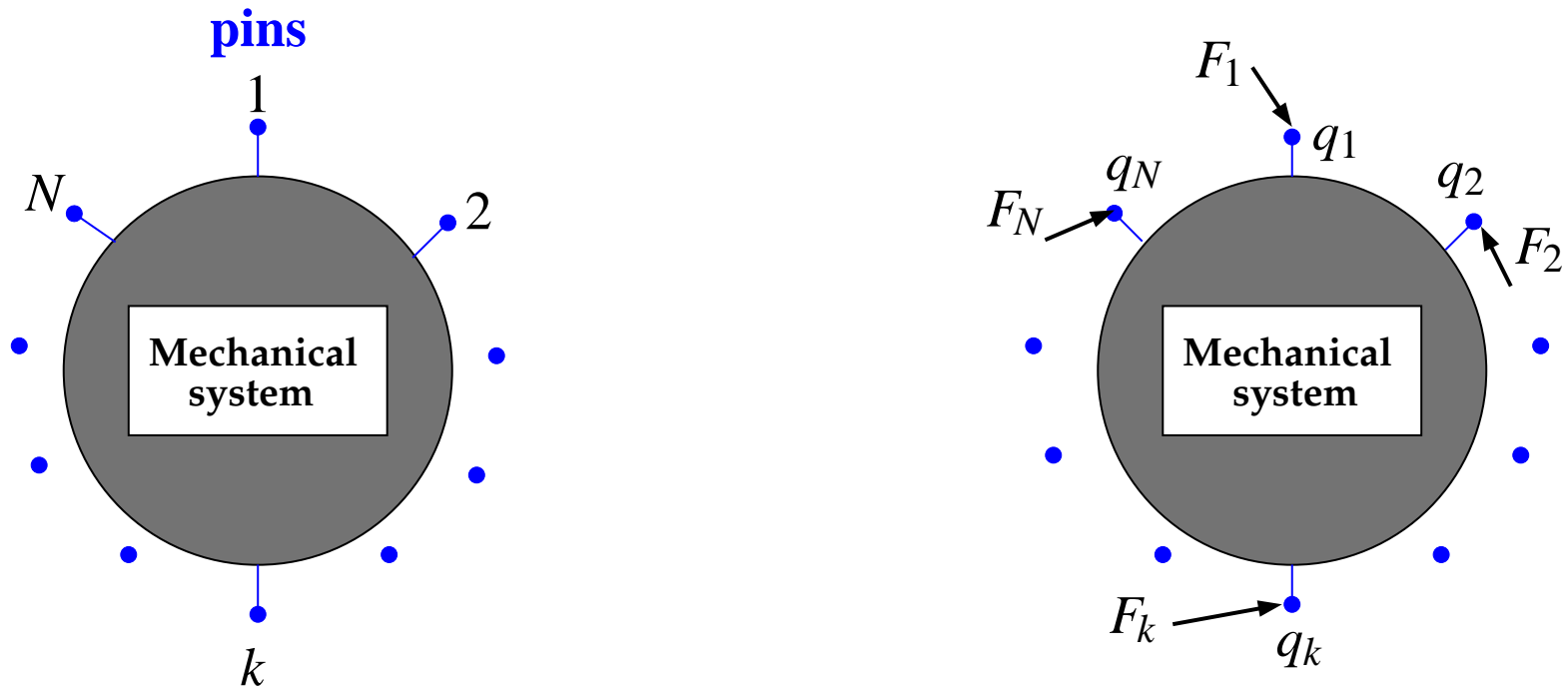

At each terminal: a **position** and a **force**.

$\rightsquigarrow$  position/force trajectories  $(q, F) \in \mathcal{B} \subseteq ((\mathbb{R}^\bullet)^{2N})^{\mathbb{R}}$ .

More generally, a **position**, **force**, **angle**, and **torque**.

## Other domains

▶ Thermal systems:

At each terminal: a **temperature** and a **heat flow**.

▶ Hydraulic systems:

At each terminal: a **pressure** and a **mass flow**.

▶ Multidomain systems:

Systems with terminals of different types,  
as motors, pumps, etc.

▶ ...

# Interconnection



## Connection of terminals

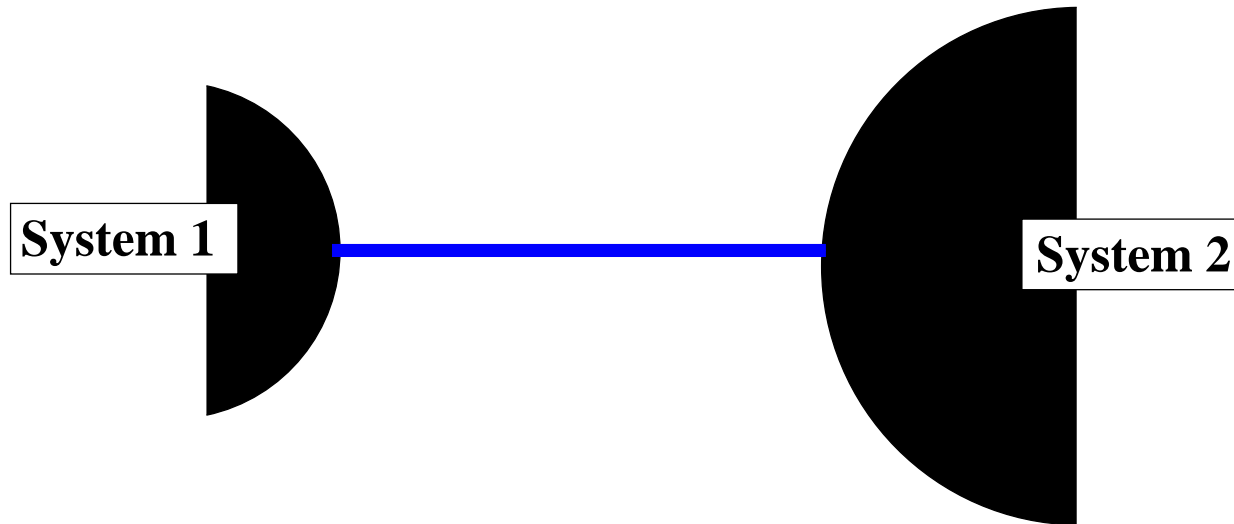

**By interconnecting, the terminal variables are equated.**

## Connection of circuit terminals

**Interconnection = connecting terminals, like soldering wires together.**

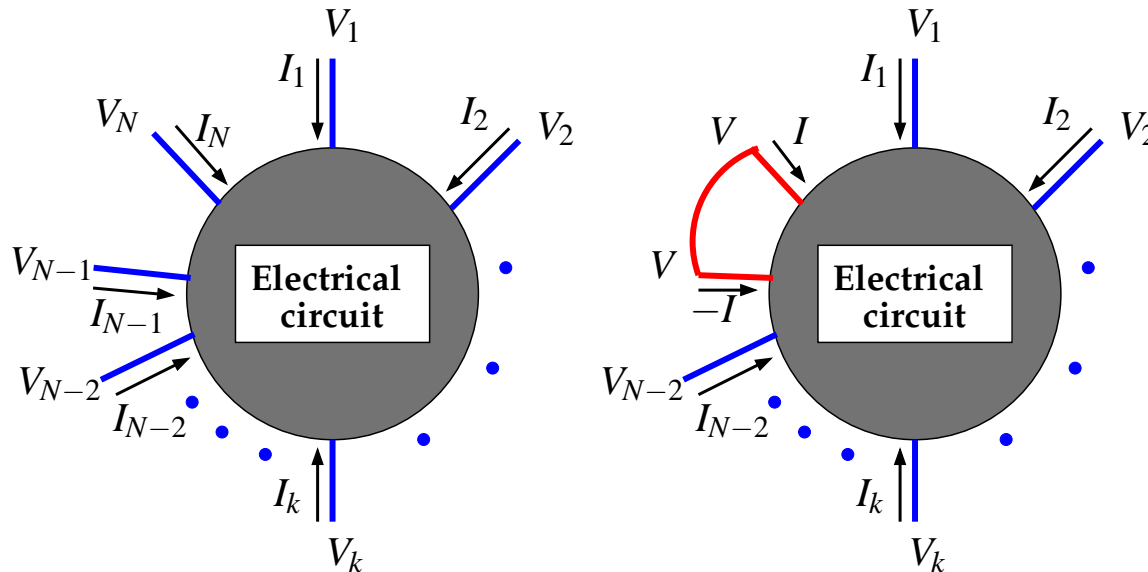

**Connecting terminals  $N - 1$  and  $N$  leads to**

$$V_{N-1} = V_N, \quad I_{N-1} + I_N = 0.$$

**After interconnection the terminals share the variables  $V_{N-1}, V_N$ , and  $I_{N-1}, I_N$  (up to a sign).**

# Connection of circuit terminals

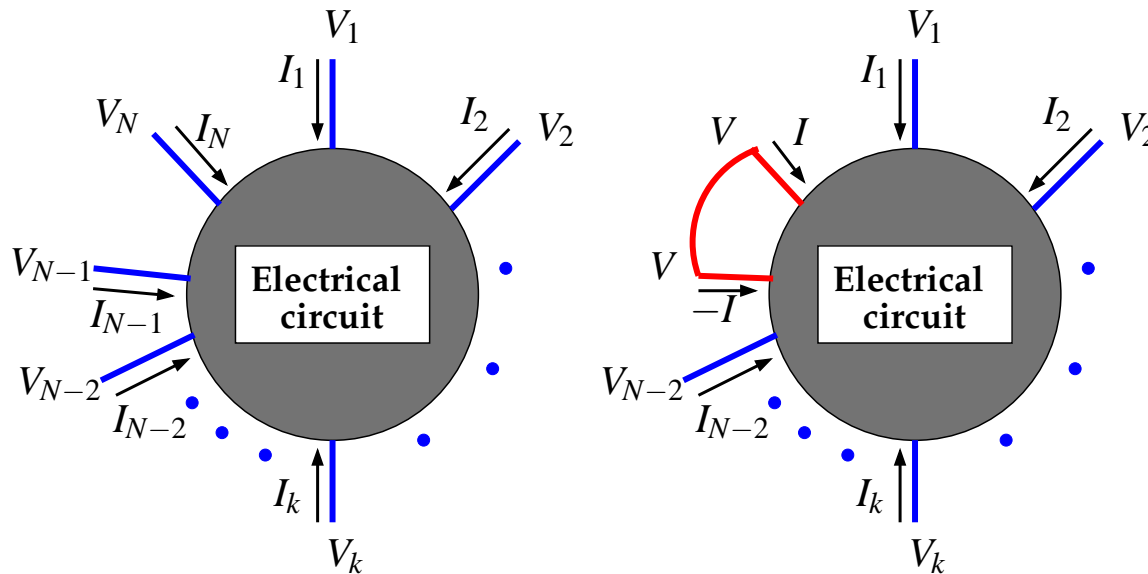

Connecting terminals  $N - 1$  and  $N$  leads to

$$V_{N-1} = V_N, \quad I_{N-1} + I_N = 0.$$

The interconnected circuit has  $N - 2$  terminals. Its behavior =

$$\mathcal{B}' = \{(V_1, I_1, V_2, I_2, \dots, V_{N-2}, I_{N-2}) : \mathbb{R} \rightarrow \mathbb{R}^{2(N-2)} \mid \exists \mathbf{V}, \mathbf{I} \text{ such that } (V_1, I_1, V_2, I_2, \dots, V_{N-2}, I_{N-2}, \mathbf{V}, \mathbf{I}, \mathbf{V}, -\mathbf{I}) \in \mathcal{B}\}.$$

# Interconnection of circuits

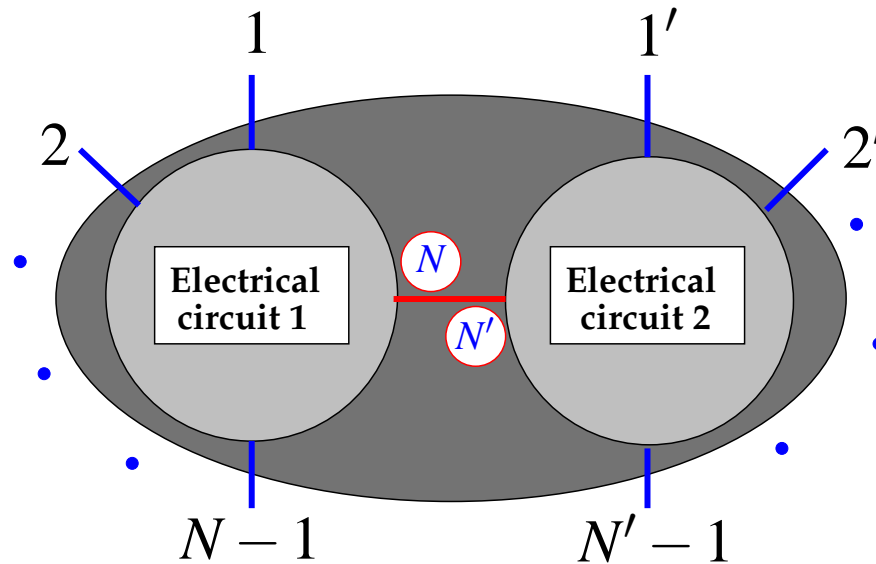

$$V_N = V_{N'} \quad \text{and} \quad I_N + I_{N'} = 0.$$

**Behavior after interconnection:**

$$\mathcal{B}_1 \sqcap \mathcal{B}_2$$

$$:= \left\{ (V_1, \dots, V_{N-1}, V_{1'}, \dots, V_{N'-1}, I_1, \dots, I_{N-1}, I_{1'}, \dots, I_{N'-1}) \mid \right.$$

$\exists V, I$  such that

$$(V_1, \dots, V_{N-1}, V, I_1, \dots, I_{N-1}, I) \in \mathcal{B}_1 \quad \text{and}$$

$$(V_{1'}, \dots, V_{N'-1}, V, I_{1'}, \dots, I_{N'-1}, -I) \in \mathcal{B}_2 \}.$$

# Interconnection of circuits

~> more terminals and more circuits connected

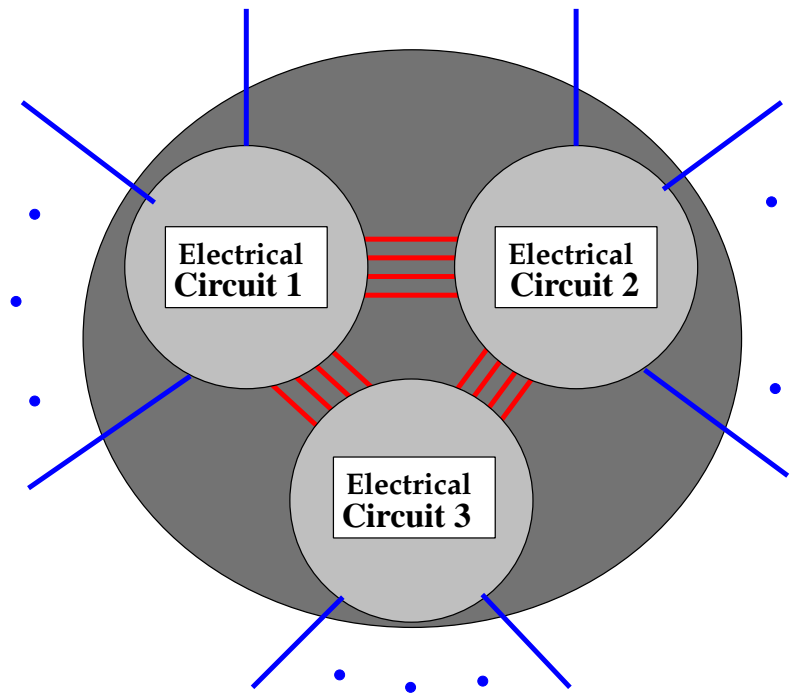

## Connection of mechanical terminals

**Interconnection = connecting terminals, like screwing pins together.**

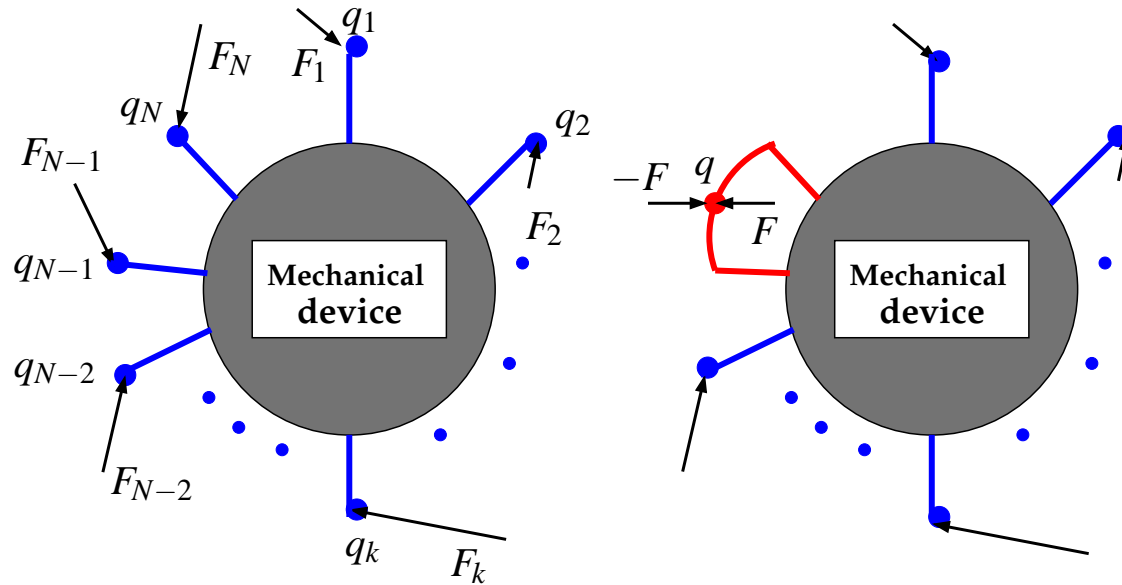

**Connecting terminals  $N - 1$  and  $N$  leads to**

$$q_{N-1} = q_N, \quad F_{N-1} + F_N = 0.$$

**After interconnection the terminals share the variables  $q_{N-1}, q_N$ , and  $F_{N-1}, F_N$  (up to a sign).**

# Connection of mechanical terminals

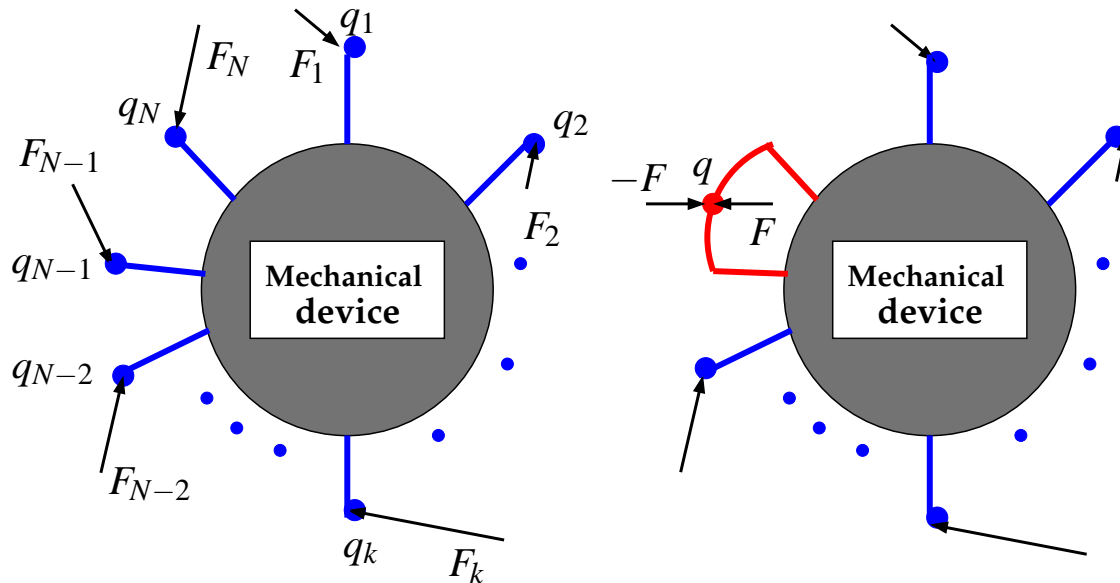

Connecting terminals  $N - 1$  and  $N$  leads to

$$q_{N-1} = q_N, \quad F_{N-1} + F_N = 0.$$

The interconnected circuit has  $N - 2$  terminals. Its behavior =

$$\mathcal{B}' = \{ (q_1, F_1, q_2, F_2, \dots, q_{N-2}, F_{N-2}) : \mathbb{R} \rightarrow \mathbb{R}^{2(N-2)} \mid \exists q, F \text{ such that } (q_1, F_1, q_2, F_2, \dots, q_{N-2}, F_{N-2}, q, F, q, -F) \in \mathcal{B} \}.$$

# Interconnection of mechanical systems

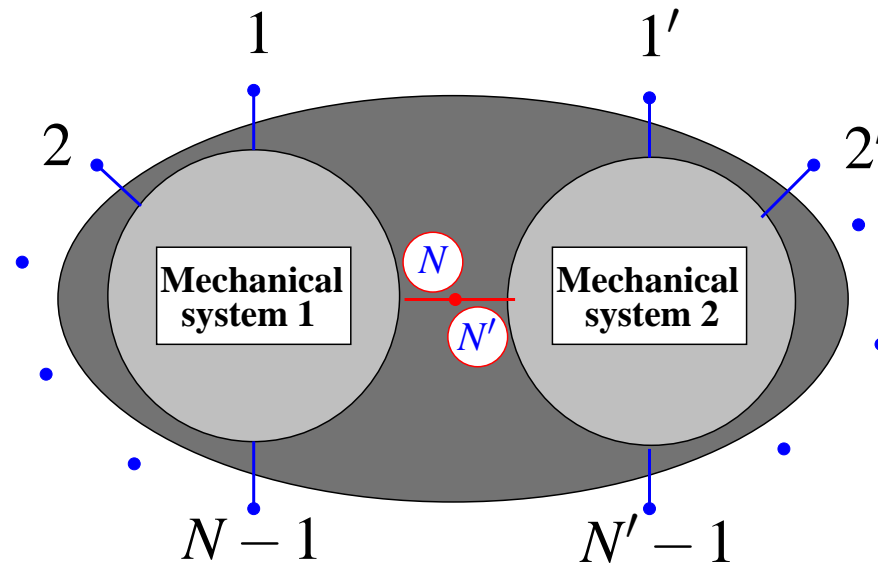

$$q_N = q_{N'} \quad \text{and} \quad F_N + F_{N'} = 0.$$



## Other terminal types

▶ Thermal systems:

At each terminal: a temperature and a heat flow.

$$T_N = T_{N'} \quad \text{and} \quad Q_N + Q_{N'} = 0.$$

▶ Hydraulic systems:

At each terminal: a pressure and a mass flow.

$$p_N = p_{N'} \quad \text{and} \quad f_N + f_{N'} = 0.$$

▶ ...

## Sharing variables

$$V_N = V_{N'} \quad \text{and} \quad I_N + I_{N'} = 0,$$

$$q_N = q_{N'} \quad \text{and} \quad F_N + F_{N'} = 0,$$

$$T_N = T_{N'} \quad \text{and} \quad Q_N + Q_{N'} = 0,$$

$$p_N = p_{N'} \quad \text{and} \quad f_N + f_{N'} = 0,$$

⋮

**Interconnection means variable sharing.**

# **Tearing, zooming, and linking**

# Tearing

∴ Model the behavior of selected variables !!

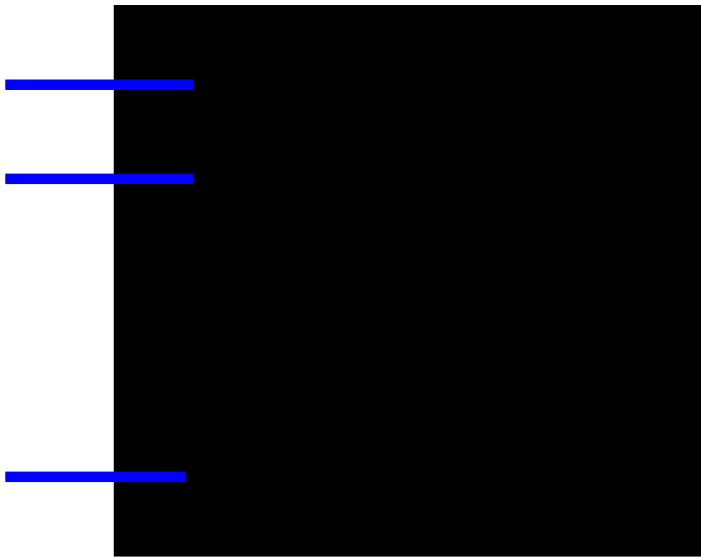

# Tearing

∴ Model the behavior of selected variables !!

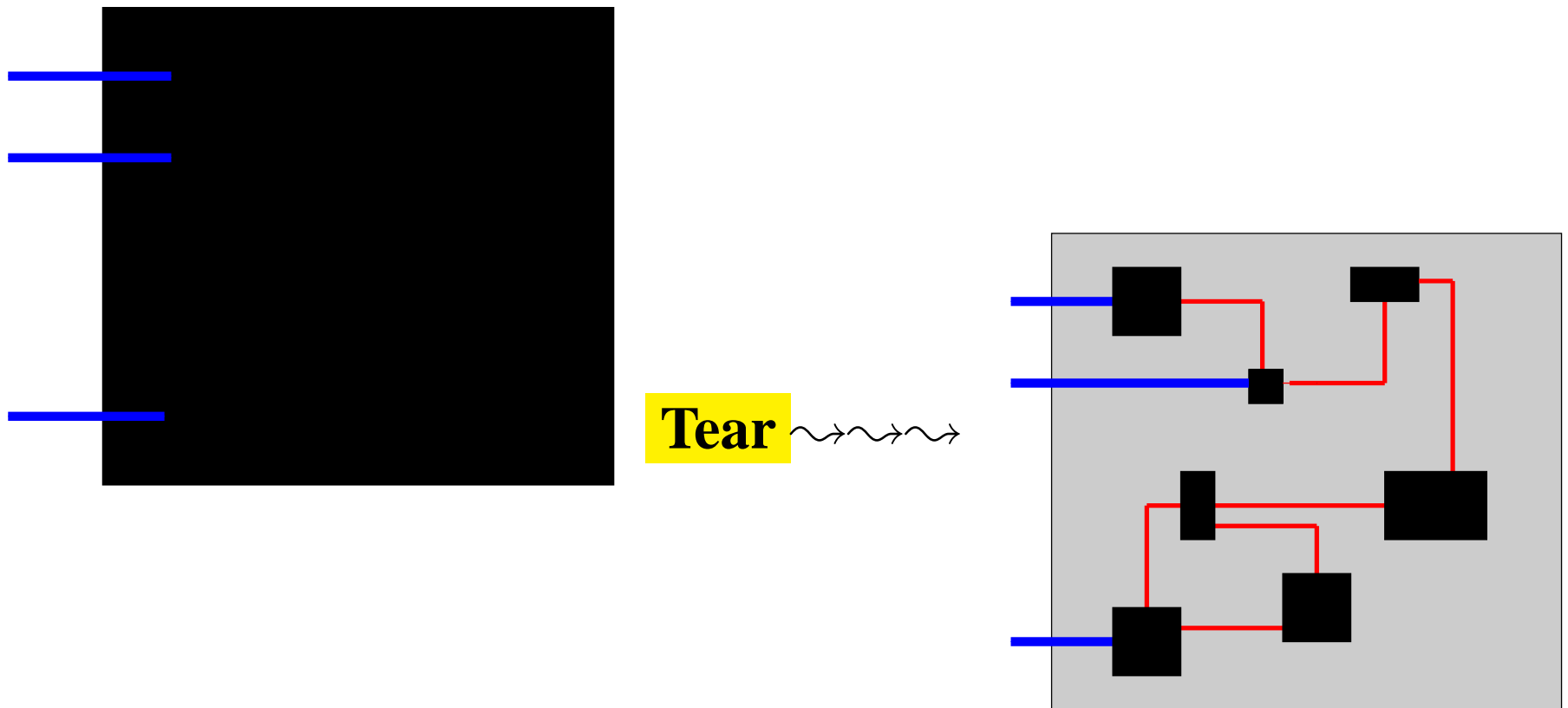

# Zooming

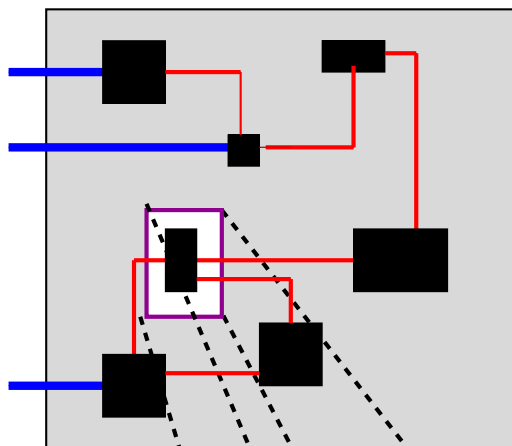

**Zoom** →

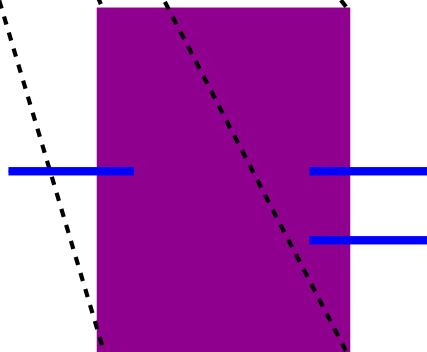

# Zooming

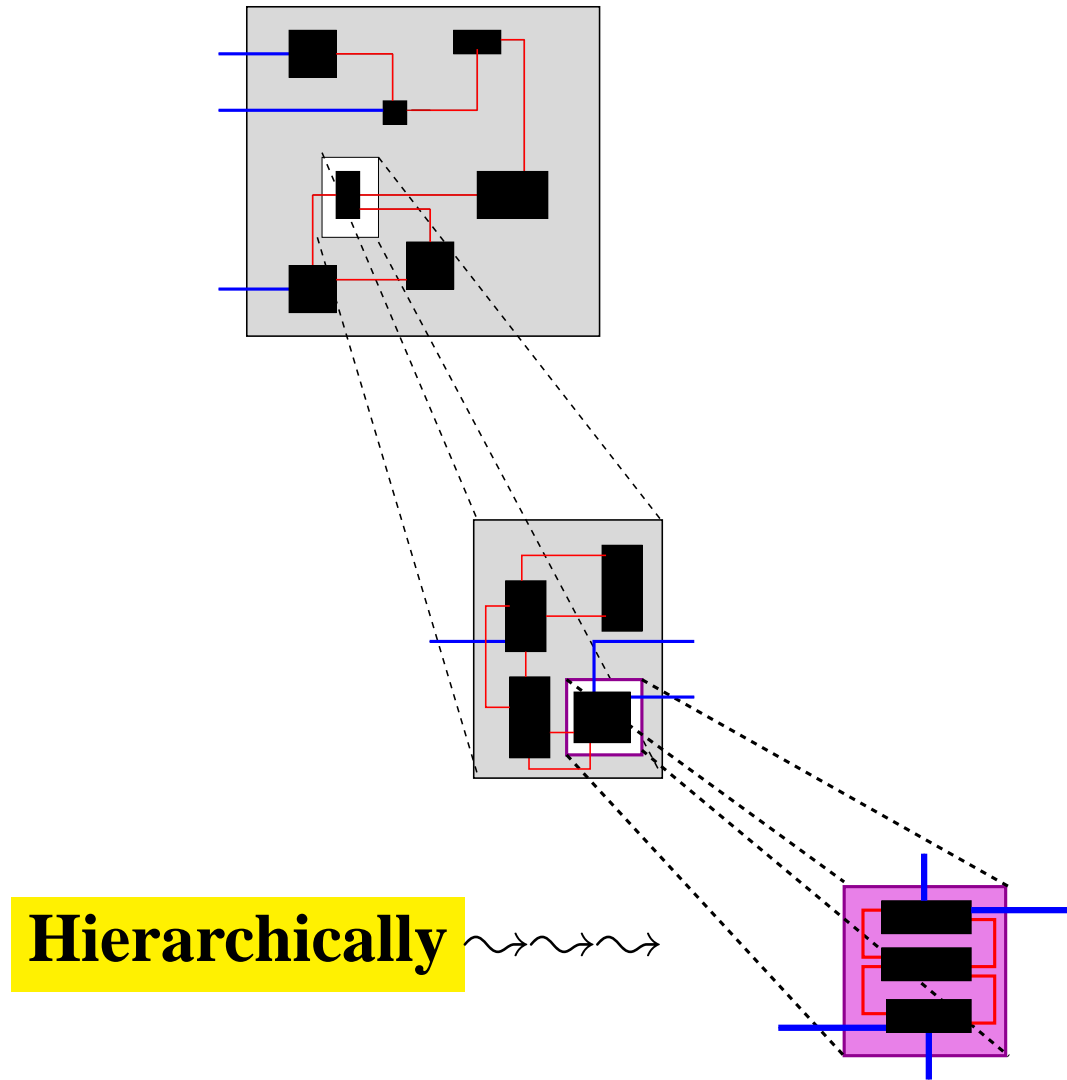

**Proceed until subsystems (‘modularity’) are obtained whose model is known, from first principles, or stored in a database.**

# Linking

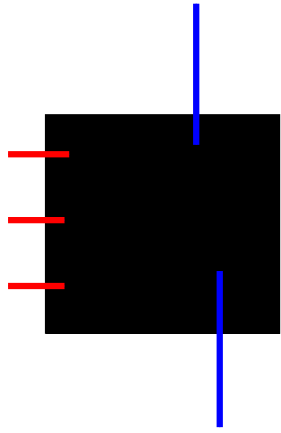
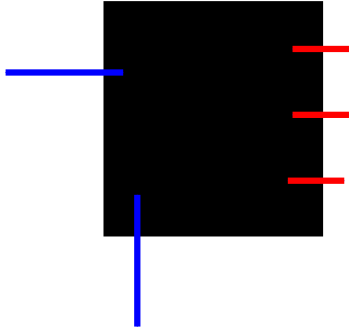



# Linking

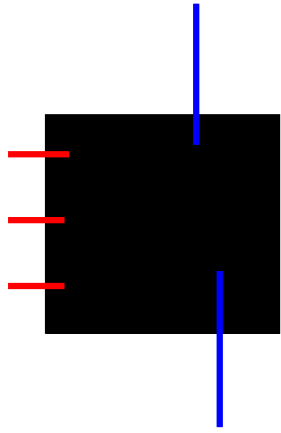
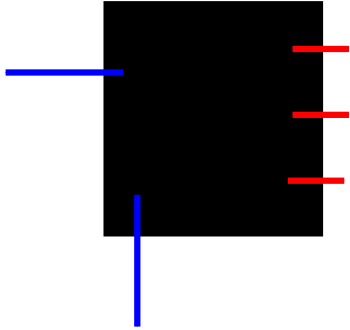

**Link** ~~~~~>

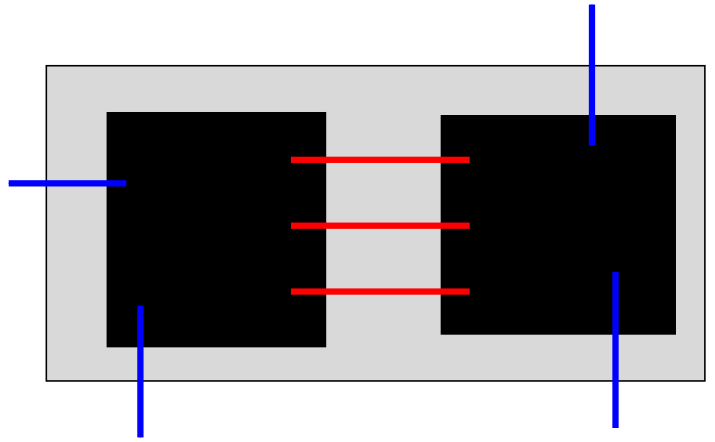

# **Interconnection architecture**

# Graph with leaves

A graph with leaves  $:\Leftrightarrow$

$$\mathcal{G} = (\mathbb{V}, \mathbb{E}, \mathbb{L}, f_{\mathbb{E}}, f_{\mathbb{L}})$$

$\mathbb{V}$  a finite set of *vertices*,

$\mathbb{E}$  a finite set of *edges*,

$\mathbb{L}$  a finite set of *leaves*,

$f_{\mathbb{E}}$  the edge incidence map,

$f_{\mathbb{L}}$  the leaf incidence map.

$f_{\mathbb{E}}$  maps each element  $e \in \mathbb{E}$  into

an unordered pair  $[v_1, v_2]$ , with  $v_1, v_2 \in \mathbb{V}$ ,

$f_{\mathbb{L}}$  is a map from  $\mathbb{L}$  to  $\mathbb{V}$ , it maps each element

$\ell \in \mathbb{L}$  into an element  $v \in \mathbb{V}$ .

# Graph with leaves

Example:

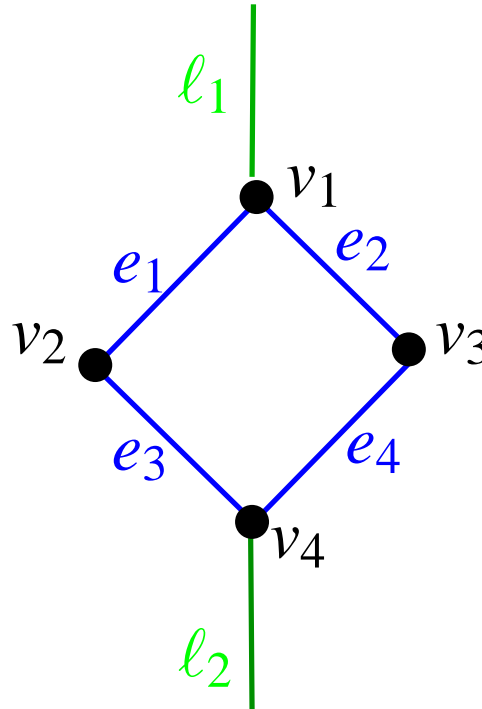

$$f_{\mathbb{E}} : e_1 \mapsto [v_1, v_2], e_2 \mapsto [v_1, v_3], e_3 \mapsto [v_2, v_4], e_4 \mapsto [v_3, v_4].$$

$$f_{\mathbb{L}} : l_1 \mapsto v_1, l_2 \mapsto v_4.$$

## Formalization of interconnected system

**An interconnected system is identified with a graph with leaves**

$$\mathcal{G} = (\mathbb{V}, \mathbb{E}, \mathbb{L}, f_{\mathbb{E}}, f_{\mathbb{L}}).$$

**The vertices**  $\leftrightarrow$  **subsystems**  
**The edges**  $\leftrightarrow$  **connections,**  
**The leaves**  $\leftrightarrow$  **external terminals.**

## Model specification

A model is obtained as follows.

- ▶ For each subsystem, specify the behavior of the variables on its terminals, i.e. on the edges and the leaves that are incident to the vertex corresponding to the subsystem.
- ▶ For each connection, specify the sharing variable conditions on the connected terminals. I.e., for each edge, specify the interconnection constraints on the variables of the subsystem terminals that correspond to the edges.
- ▶ Specify the manifest variables.

**Subsystems in the vertices.**

**Connections in the edges.**

**External terminals in the leaves.**

# Example

## A transmission line

Consider the transmission line shown below.

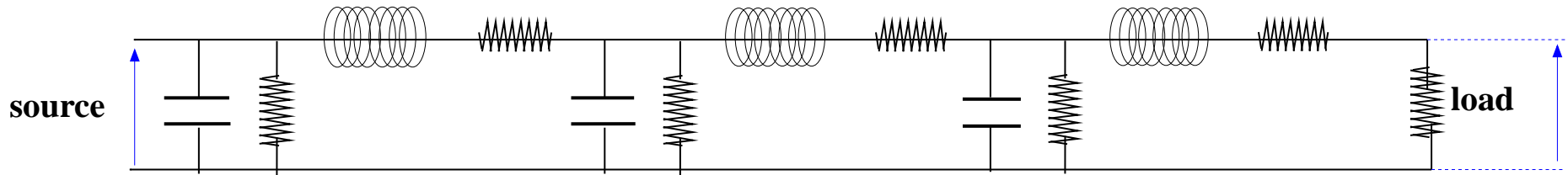

The aim is to model the relation between the voltage of the source on the left and the voltage across the load on the right.



# A transmission line

**View the system as an interconnection of 4 subsystems.**

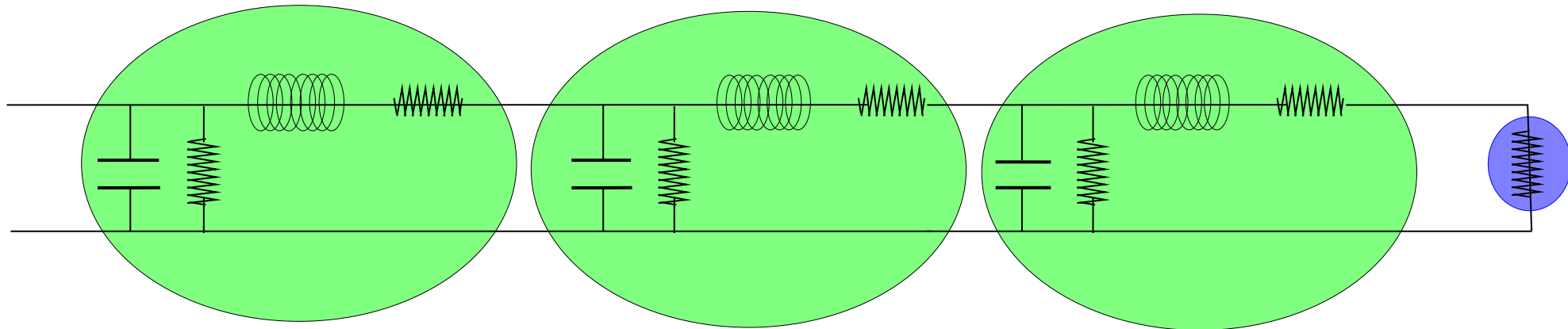

# A transmission line

View the system as an interconnection of 4 subsystems.

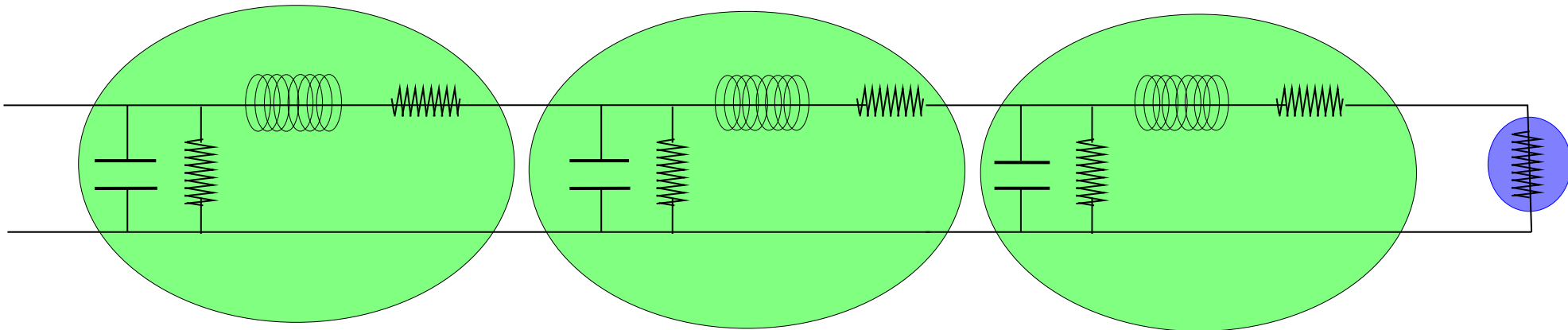

The interconnection architecture  $\leadsto$  the graph with leaves

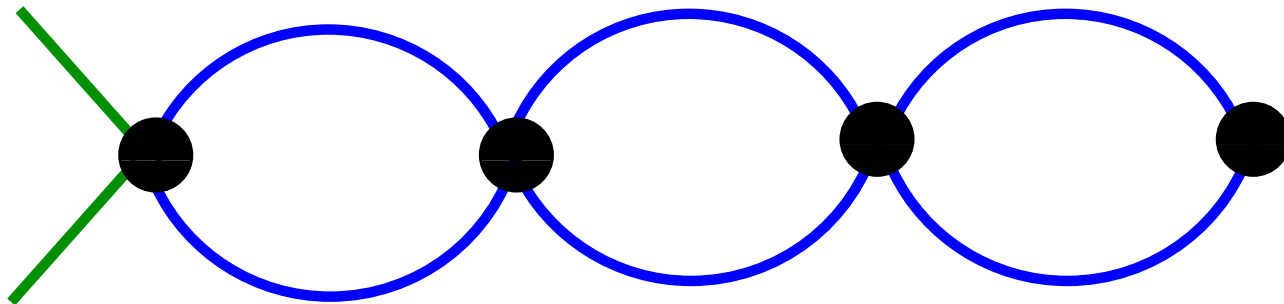

# A transmission line

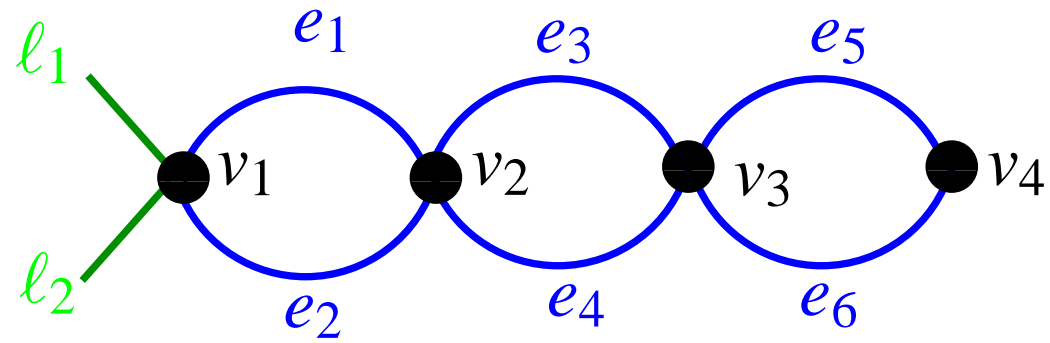

## A transmission line

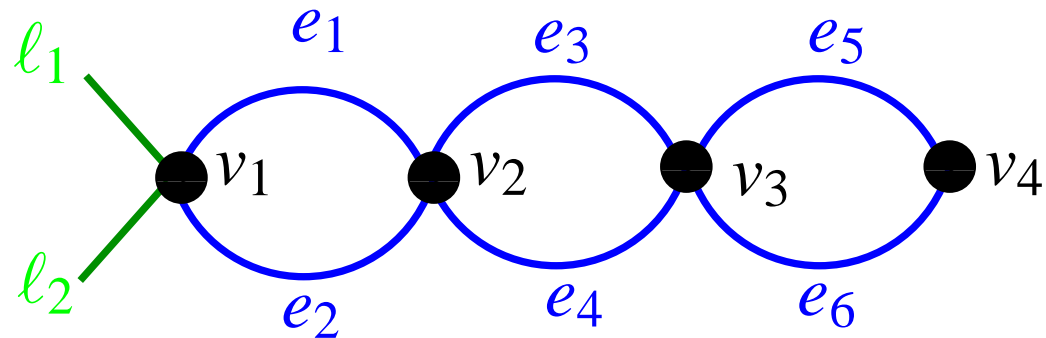

**In vertices  $v_1, v_2, v_3$  we have identical subsystems. We deal with them later.**

**In vertex  $v_4$  there is a resistor  $\rightsquigarrow$**

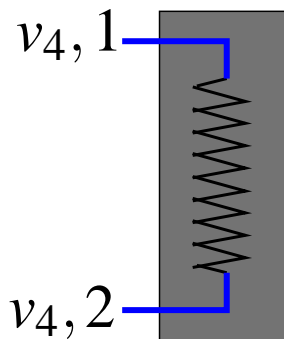

$$V_{v_{4,1}} - V_{v_{4,2}} = R I_{v_{4,1}}, \quad I_{v_{4,1}} + I_{v_{4,2}} = 0.$$

## A transmission line section

In each of the vertices  $v_1, v_2, v_3$  we have:

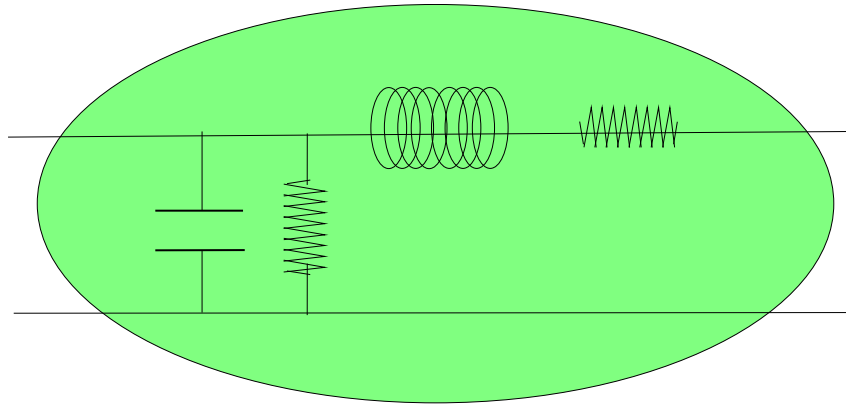

This system can be viewed as the interconnection of 6 subsystems:

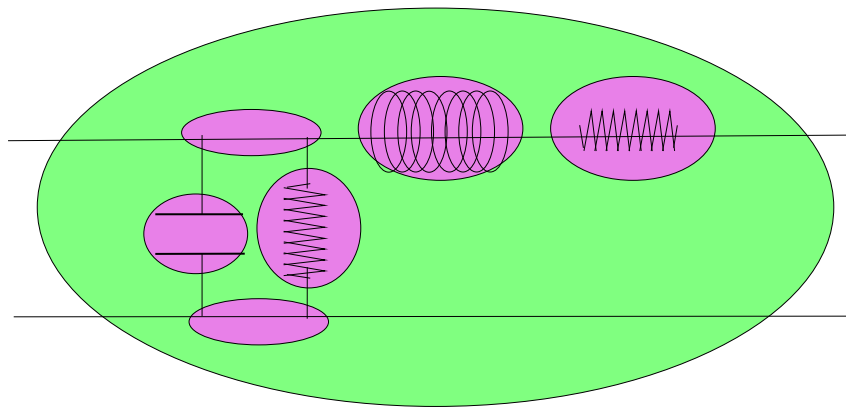

## A transmission line section

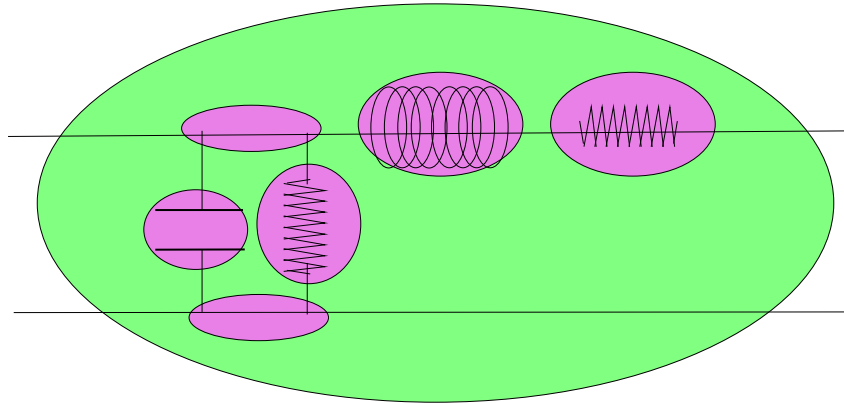

The associated interconnection architecture is

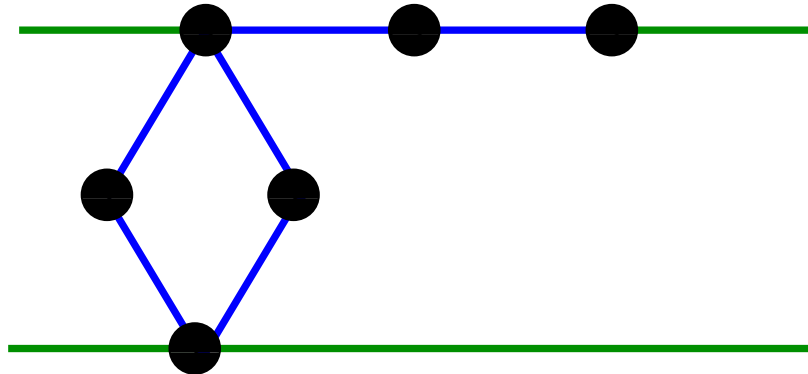

## A transmission line section

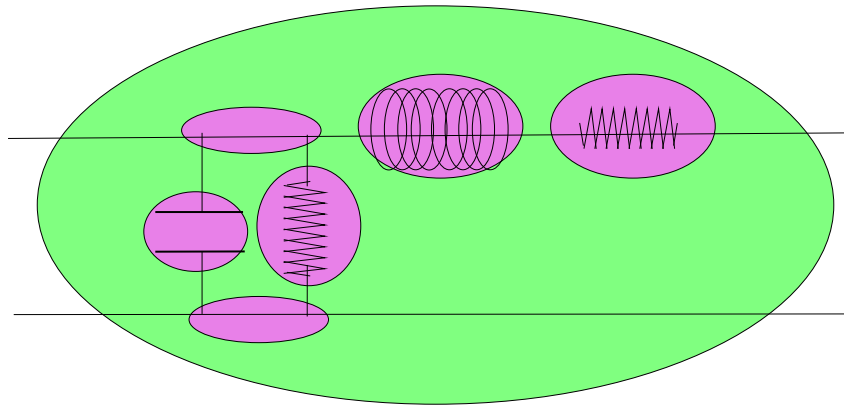

The associated interconnection architecture is

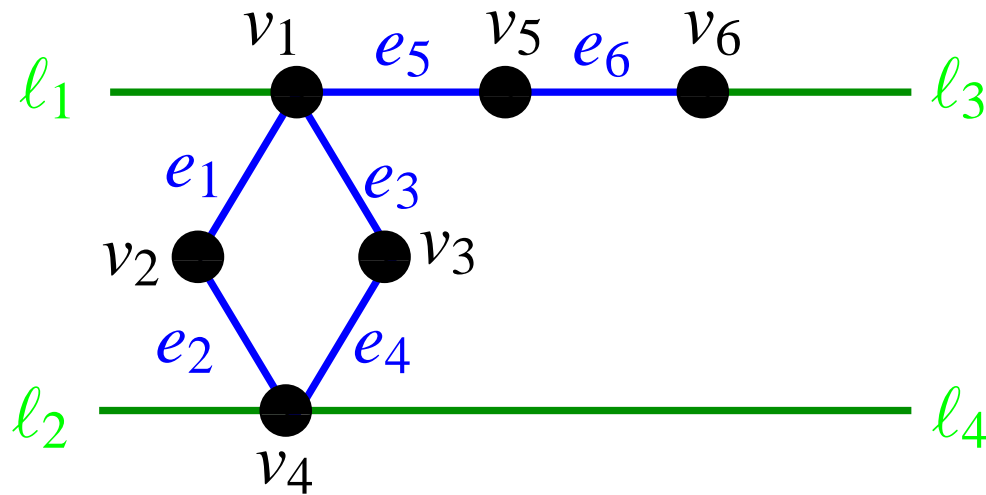

## Modeling the transmission line section

**Subsystems: 2 resistors, 1 inductor, 1 capacitor, 2 connectors.**

**The inductor in vertex  $v_5$ , for example,  $\rightsquigarrow$**

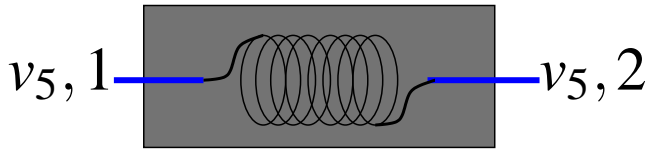

$$V_{v_{5,1}} - V_{v_{5,2}} = L \frac{d}{dt} I_{v_{5,1}}, \quad I_{v_{5,1}} + I_{v_{5,2}} = 0.$$



## Modeling the transmission line section

**Subsystems: 2 resistors, 1 inductor, 1 capacitor, 2 connectors.**

**The inductor in vertex  $v_5$ , for example,  $\rightsquigarrow$**

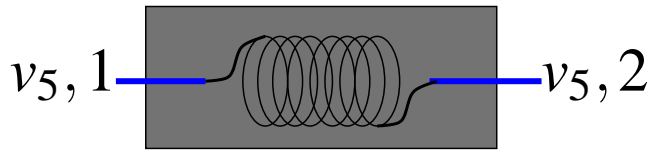

$$V_{v_5,1} - V_{v_5,2} = L \frac{d}{dt} I_{v_5,1}, \quad I_{v_5,1} + I_{v_5,2} = 0.$$

**The connector in vertex  $v_1$ , for example,  $\rightsquigarrow$**

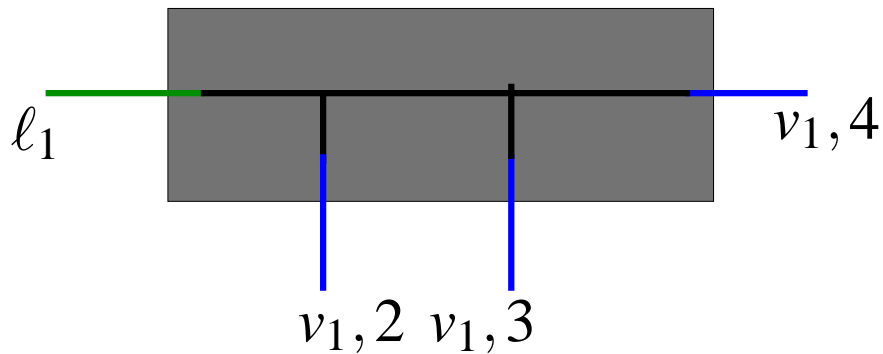

$$V_{l_1} = V_{v_1,2} = V_{v_1,3} = V_{v_1,4}, \quad I_{l_1} + I_{v_1,2} + I_{v_1,3} + I_{v_1,4} = 0.$$

**For each vertex we obtain a set of equations.**

## Modeling the transmission line section

The connection equations for edge  $e_5$ , for example,  $\rightsquigarrow$

$$V_{v_1,4} = V_{v_5,1}, \quad I_{v_1,4} + I_{v_5,1} = 0.$$

For each edge we obtain two such equations.

## Modeling the transmission line section

**For each vertex and for each edge we obtain a set of equations.  
The manifest variables for this subsystem are**

$$V_{l_1}, I_{l_1}, V_{l_2}, I_{l_2}, V_{l_3}, I_{l_3}, V_{l_4}, I_{l_4}.$$

**The latent variables are**

$$V_{v_1,1}, I_{v_1,1}, \dots, V_{v_6,1}, I_{v_6,1}.$$

## Modeling the transmission line section

**For each vertex and for each edge we obtain a set of equations.  
The manifest variables for this subsystem are**

$$V_{l_1}, I_{l_1}, V_{l_2}, I_{l_2}, V_{l_3}, I_{l_3}, V_{l_4}, I_{l_4}.$$

**The latent variables are**

$$V_{v_1,1}, I_{v_1,1}, \dots, V_{v_6,1}, I_{v_6,1}.$$

**Eliminating the latent variables,  $\rightsquigarrow$  a LTIDS with (4) ODEs in the variables**

$$V_{l_1}, I_{l_1}, V_{l_2}, I_{l_2}, V_{l_3}, I_{l_3}, V_{l_4}, I_{l_4}.$$

## Modeling the transmission line section

Denote these equations as

$$R \left( \frac{d}{dt} \right) \begin{bmatrix} V_{l_1} \\ I_{l_1} \\ V_{l_2} \\ I_{l_2} \\ V_{l_3} \\ I_{l_3} \\ V_{l_4} \\ I_{l_4} \end{bmatrix} = 0.$$

**Note:** For RLC-circuits, as is the case here, there are more efficient ways to arrive at these equations (see Lecture V).

## A transmission line

Going back to the transmission line yields the subsystem equations

$$R \left( \frac{d}{dt} \right) \begin{bmatrix} \begin{bmatrix} V_{\ell_1} \\ I_{\ell_1} \\ V_{v_1,2} \\ I_{v_1,2} \\ V_{v_1,3} \\ I_{v_1,3} \\ V_{v_1,4} \\ I_{v_1,4} \end{bmatrix} \\ \begin{bmatrix} V_{v_2,1} \\ I_{v_2,2} \\ V_{v_2,2} \\ I_{v_2,2} \\ V_{v_2,3} \\ I_{v_2,3} \\ V_{v_2,4} \\ I_{v_2,4} \end{bmatrix} \\ \begin{bmatrix} V_{v_3,1} \\ I_{v_3,2} \\ V_{v_3,2} \\ I_{v_3,2} \\ V_{v_3,3} \\ I_{v_3,3} \\ V_{v_3,4} \\ I_{v_3,4} \end{bmatrix} \end{bmatrix} = 0,$$

$$V_{v_4,1} - V_{v_4,2} = R I_{v_4,1}, \quad I_{v_4,1} + I_{v_4,2} = 0,$$

## A transmission line

and the interconnection equations

$$V_{v_1,3} = V_{v_2,1}, \quad I_{v_1,3} + I_{v_2,1} = 0,$$

$$V_{v_1,4} = V_{v_2,2}, \quad I_{v_1,4} + I_{v_2,2} = 0,$$

$$V_{v_2,3} = V_{v_3,1}, \quad I_{v_2,3} + I_{v_3,1} = 0,$$

$$V_{v_2,4} = V_{v_3,2}, \quad I_{v_2,4} + I_{v_3,2} = 0,$$

$$V_{v_3,3} = V_{v_4,1}, \quad I_{v_4,3} + I_{v_4,1} = 0,$$

$$V_{v_3,4} = V_{v_4,2}, \quad I_{v_3,4} + I_{v_4,2} = 0.$$

## A transmission line

and the interconnection equations

$$\begin{aligned}V_{v_1,3} &= V_{v_2,1}, & I_{v_1,3} + I_{v_2,1} &= 0, \\V_{v_1,4} &= V_{v_2,2}, & I_{v_1,4} + I_{v_2,2} &= 0, \\V_{v_2,3} &= V_{v_3,1}, & I_{v_2,3} + I_{v_3,1} &= 0, \\V_{v_2,4} &= V_{v_3,2}, & I_{v_2,4} + I_{v_3,2} &= 0, \\V_{v_3,3} &= V_{v_4,1}, & I_{v_4,3} + I_{v_4,1} &= 0, \\V_{v_3,4} &= V_{v_4,2}, & I_{v_3,4} + I_{v_4,2} &= 0.\end{aligned}$$

Finally, there is the manifest variable assignment

$$w_1 = V_{l_1} - V_{l_2}, \quad w_2 = V_{v_4,1} - V_{v_4,2}.$$



## A transmission line

**After elimination of the latent variables, we obtain the desired differential equation that describes the behavior of  $(w_1, w_2)$**

$$r_1 \left( \frac{d}{dt} \right) w_1 = r_2 \left( \frac{d}{dt} \right) w_2.$$

**In practice, all these steps need to be carried out more explicitly, faster, better, and more reliably with the help of software and a computer toolbox.**

**Input/output**

**versus**

**tearing, zooming, and linking**

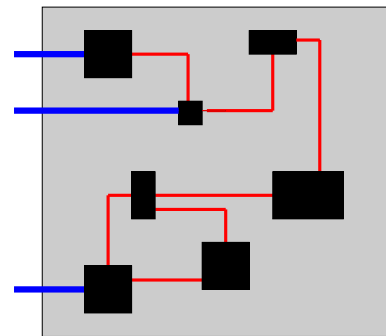
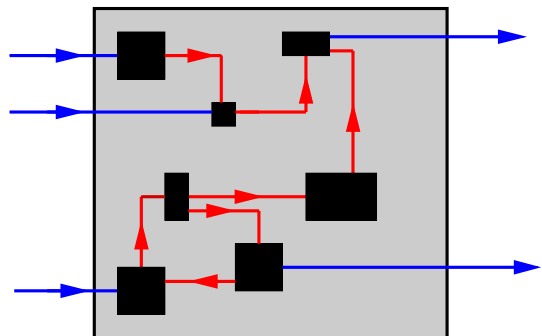
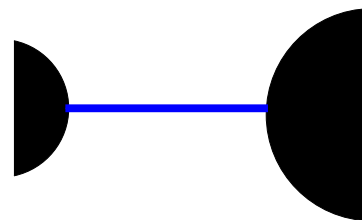
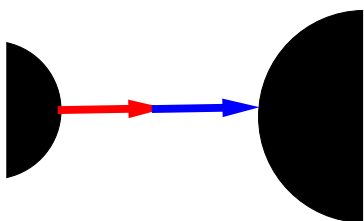
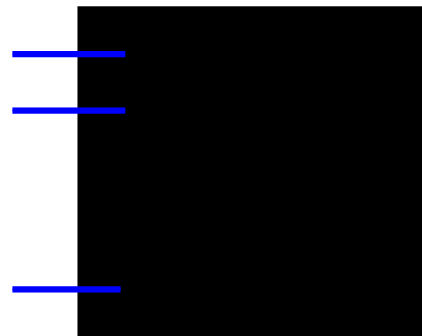
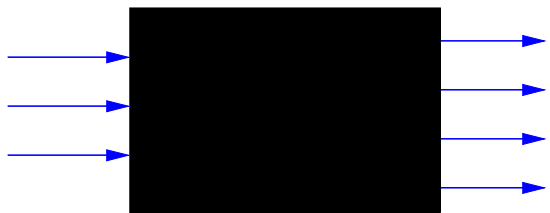

# **Control as interconnection**

# Feedback control

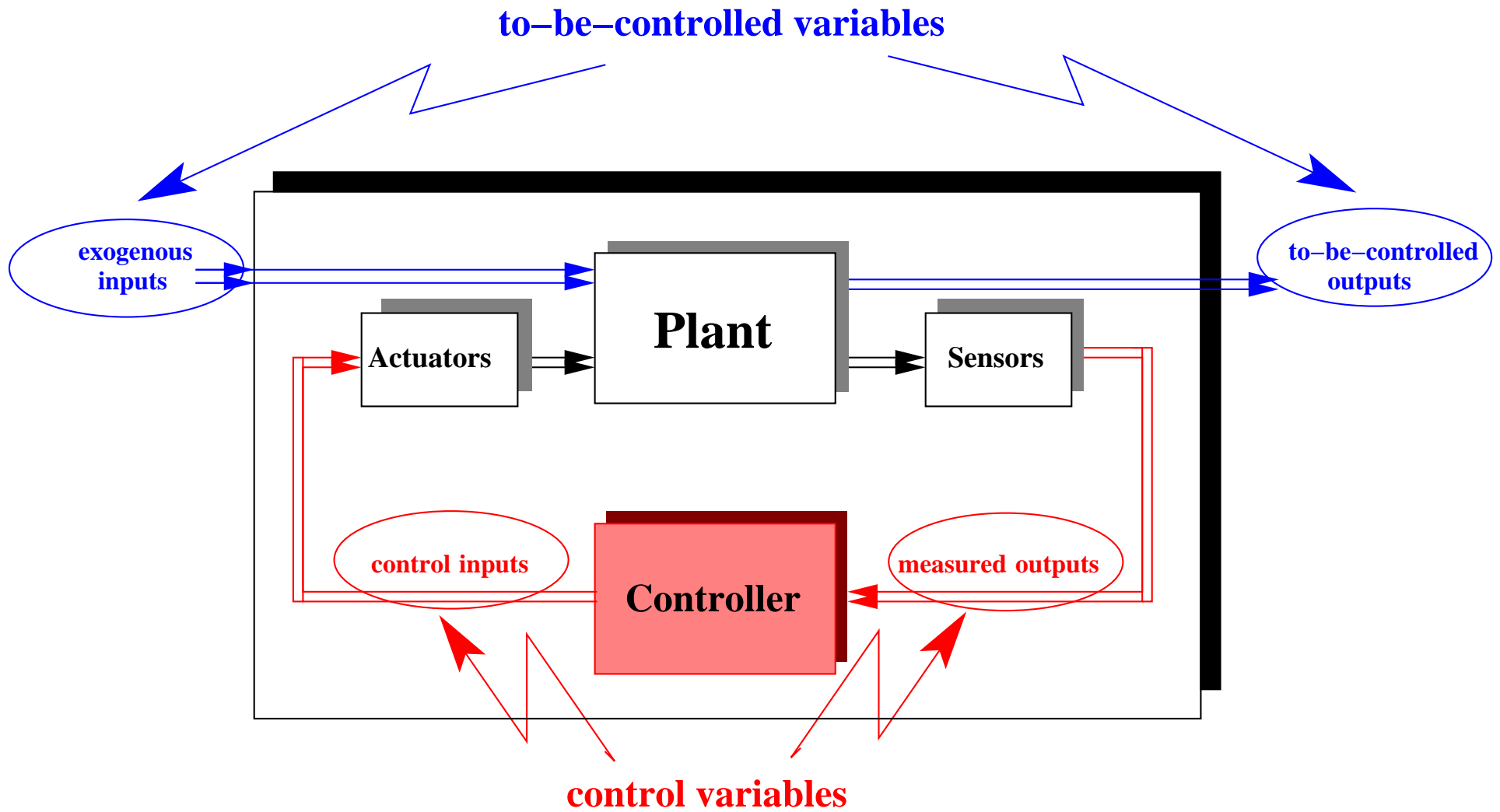

# Behavioral control

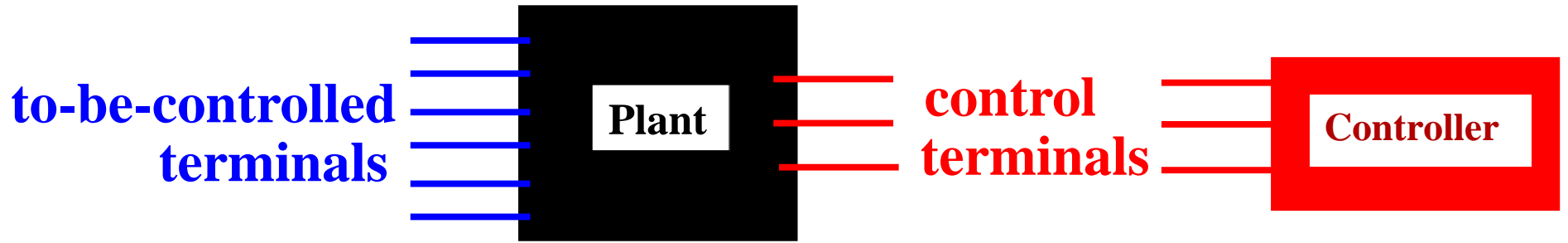

# Behavioral control

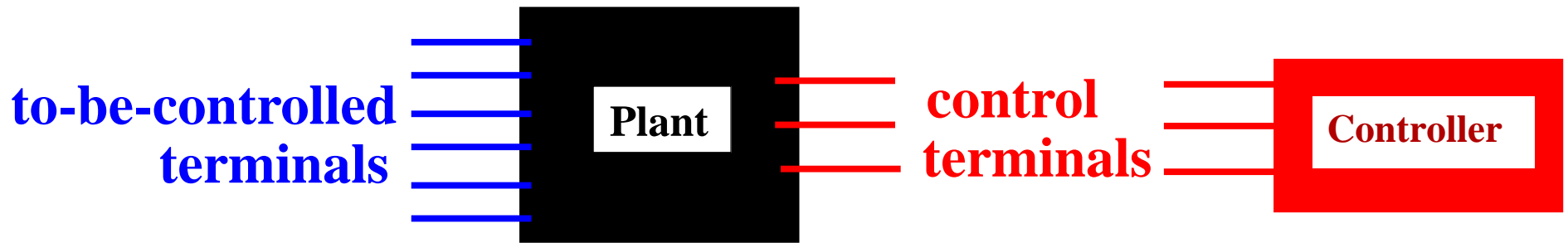

**control = interconnection.**

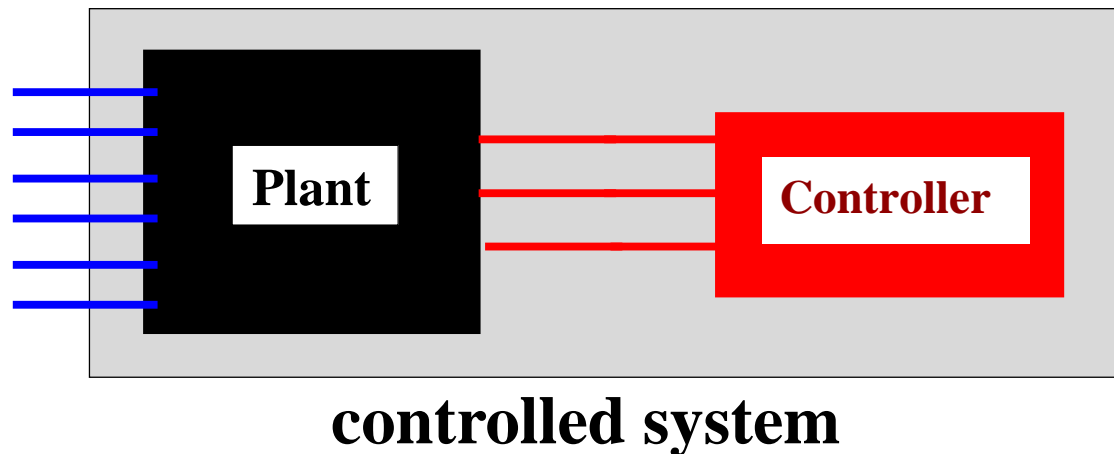

# A 'quarter car'

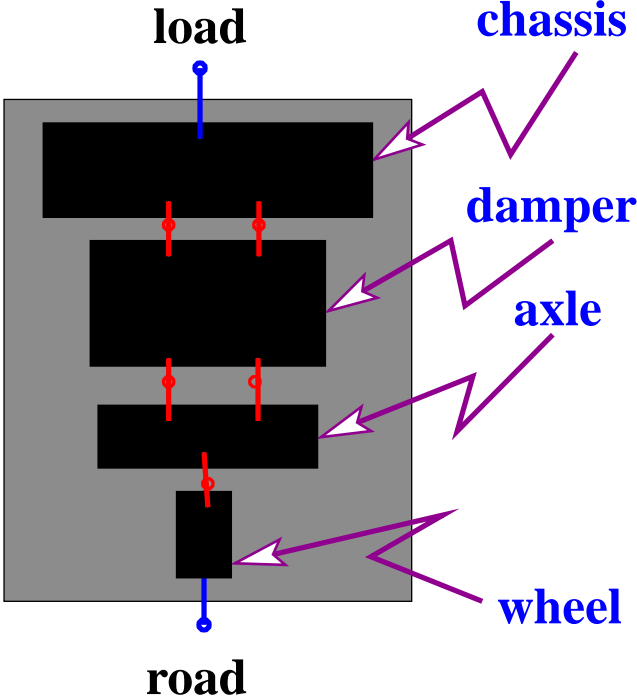



# A 'quarter car'

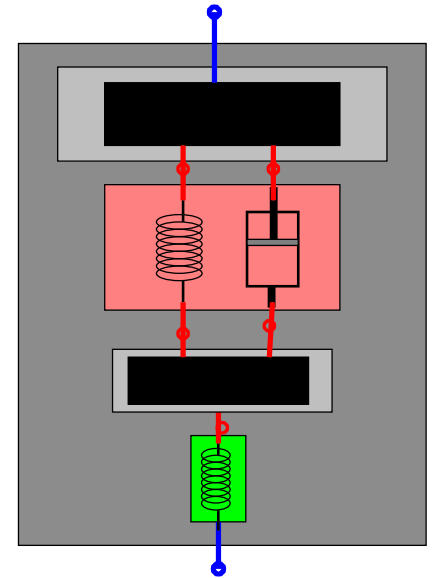
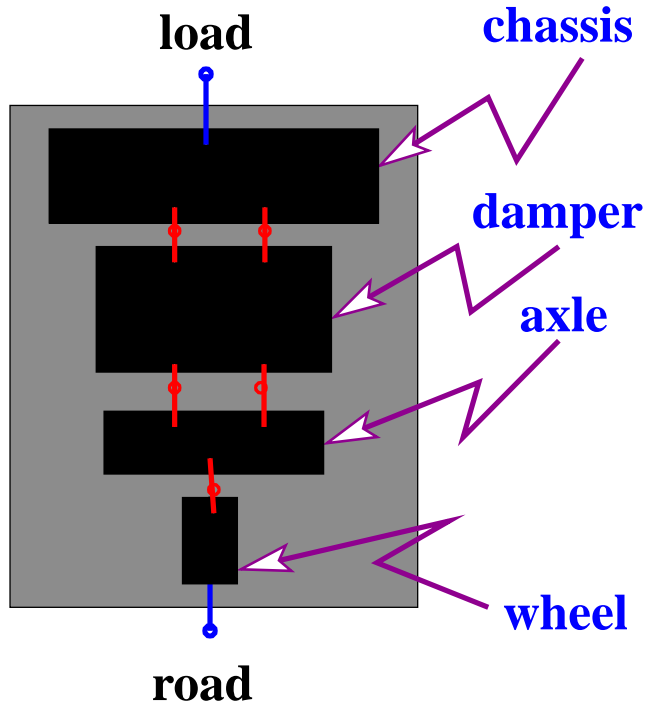

# A 'quarter car'

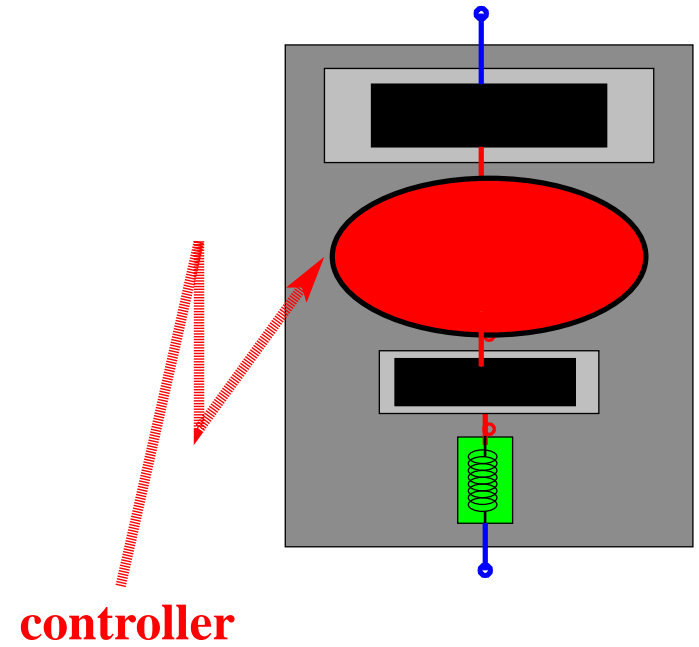
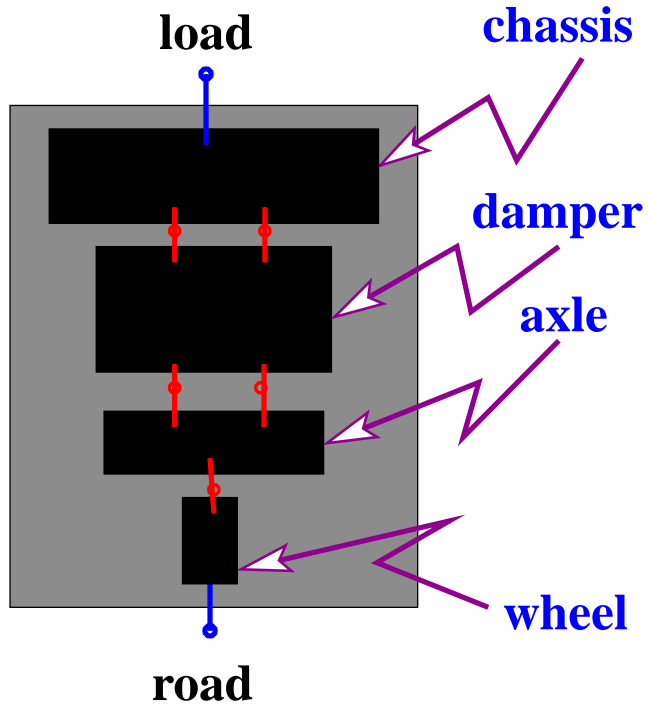

# A 'quarter car'

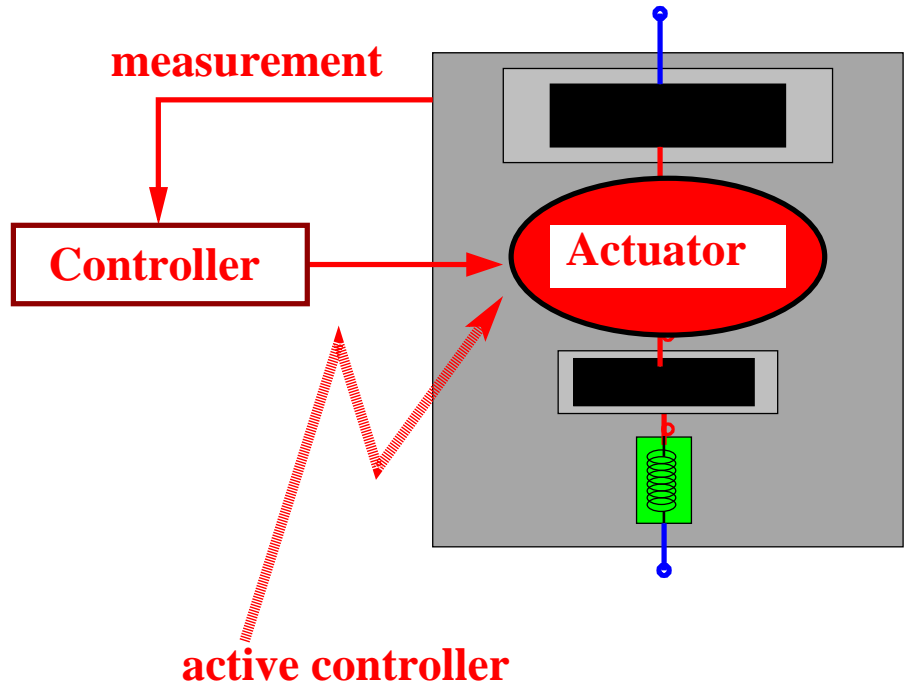
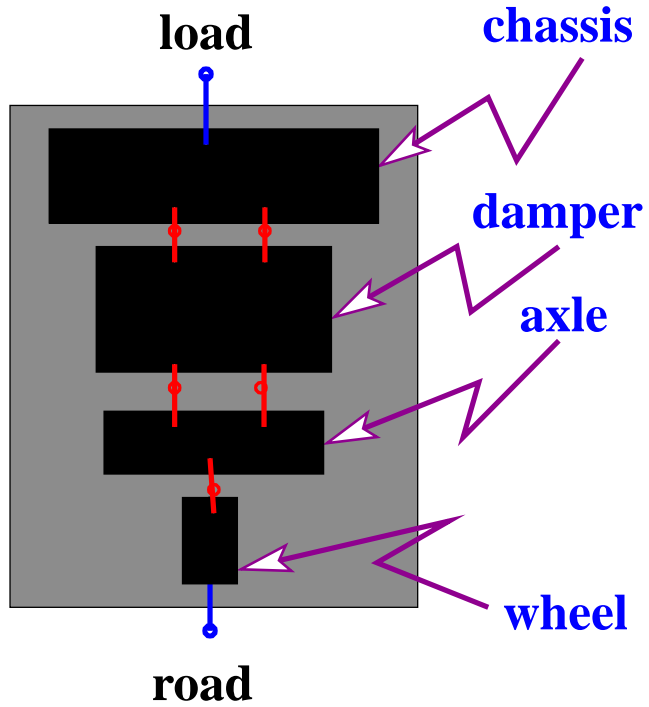

# A 'quarter car'

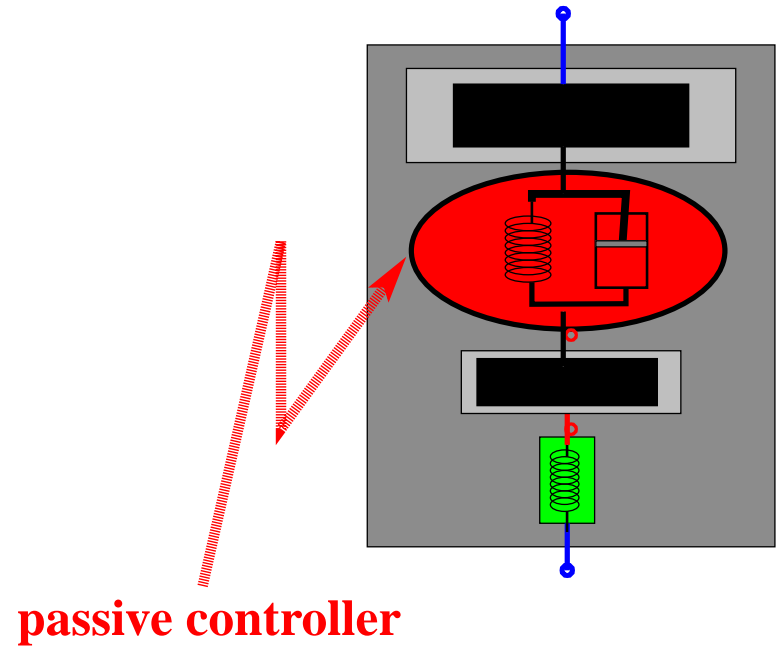
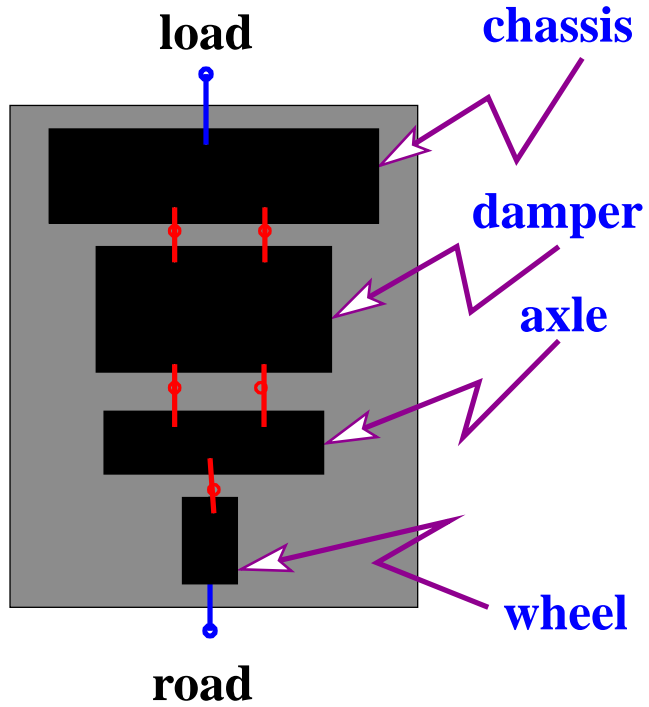

# Suspension controllers in Formula 1



**Nigel Mansell victorious in 1992 with an active damper suspension.**

**Active dampers were banned in 1994 to break the dominance of the Williams team.**

# Suspension controllers in Formula 1

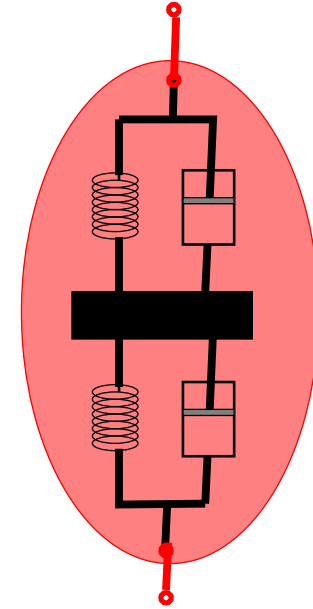

**Renault successfully uses a passive ‘tuned mass damper’ in 2005/2006.**

**Banned in 2006, under the ‘movable aerodynamic devices’ clause.**

# Suspension controllers in Formula 1

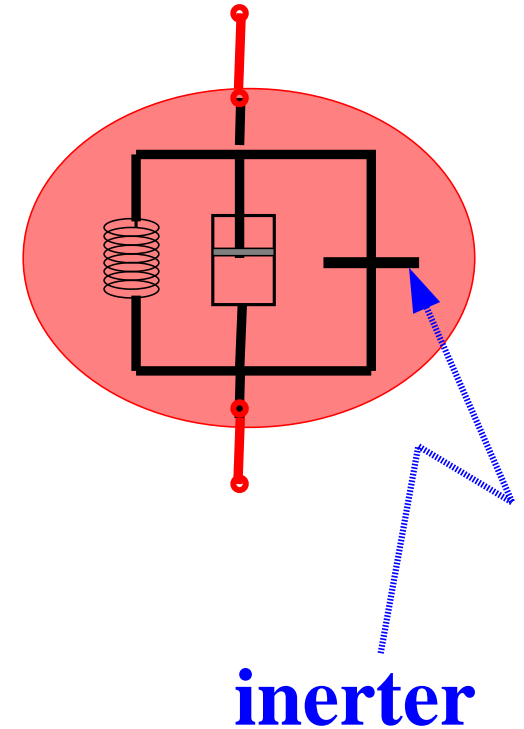

**Kimi Räikkönen wins the 2005 Grand Prix in Spain with McLaren's 'J-damper' (see Lecture V).**

# **Pole placement and stabilization**



## LTIDSs as controllers

We consider only ‘full control’.

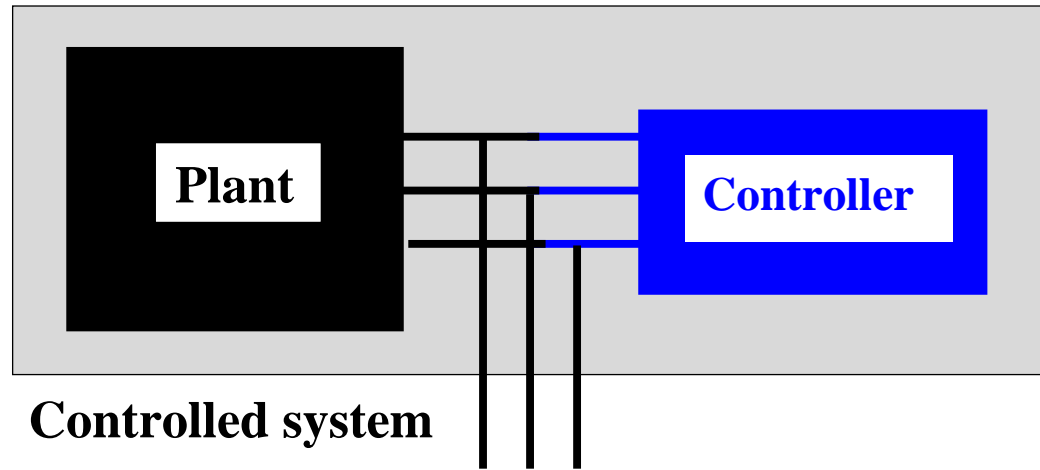

and controllers such that the controlled system is autonomous.

## LTIDSs as controllers

Consider a LTIDS  $\mathcal{P} \in \mathcal{L}^w$ , the *plant*,  
and a LTIDS  $\mathcal{C} \in \mathcal{L}^w$  the *controller*.

[[ $\mathcal{C}$  is called a *regular controller* for  $\mathcal{P}$ ]]  $:\Leftrightarrow$

[[(i)  $p(\mathcal{C}) = m(\mathcal{P})$  and (ii)  $\mathcal{P} \cap \mathcal{C}$  is autonomous]].

## LTIDSs as controllers

Consider a LTIDS  $\mathcal{P} \in \mathcal{L}^w$ , the *plant*,  
and a LTIDS  $\mathcal{C} \in \mathcal{L}^w$  the *controller*.

[[ $\mathcal{C}$  is called a *regular controller* for  $\mathcal{P}$ ]]  $:\Leftrightarrow$

[[(i)  $p(\mathcal{C}) = m(\mathcal{P})$  and (ii)  $\mathcal{P} \cap \mathcal{C}$  is autonomous]].

**In terms of minimal kernel representations**

$$\begin{aligned} P \left( \frac{d}{dt} \right) w &= 0 \\ C \left( \frac{d}{dt} \right) w &= 0 \end{aligned}$$

for  $\mathcal{P}$  and  $\mathcal{C}$ , regularity  $\Leftrightarrow \begin{bmatrix} P \\ C \end{bmatrix}$  square and nonsingular.

## The characteristic polynomial

Let  $\mathcal{B} \in \mathcal{L}^w$  be autonomous, and  $R \left( \frac{d}{dt} \right) w = 0$  be a minimal kernel representation of  $\mathcal{B}$ .

Assume that  $\text{determinant}(R)$  is monic (otherwise change  $R \rightarrow \alpha R$  with  $0 \neq \alpha \in \mathbb{R}$  suitably chosen).

The **characteristic polynomial** of  $\mathcal{B}$ ,  $\chi_{\mathcal{B}} \in \mathbb{R}[\xi]$ , is defined as

$$\chi_{\mathcal{B}} := \text{determinant}(R).$$

Note:  $\chi_{\mathcal{B}}$  is independent of the  $R$  chosen to represent  $\mathcal{B}$ .

## The characteristic polynomial

Let  $\mathcal{B} \in \mathcal{L}^w$  be autonomous, and  $R \left( \frac{d}{dt} \right) w = 0$  be a minimal kernel representation of  $\mathcal{B}$ .

The **minimal polynomial** of  $\mathcal{B}$ ,  $\mu_{\mathcal{B}} \in \mathbb{R}[\xi]$ , is defined as the monic polynomial of least degree that annihilates  $\mathcal{B}$ , i.e.

$$\mu_{\mathcal{B}} \left( \frac{d}{dt} \right) \mathcal{B} = 0,$$

$$\left[ \left[ p_{\mathcal{B}} \left( \frac{d}{dt} \right) \mathcal{B} = 0, 0 \neq p \in \mathbb{R}[\xi] \right] \Rightarrow \left[ \text{degree}(p) \geq \text{degree}(\mu_{\mathcal{B}}) \right] \right].$$

Note:  $\mu_{\mathcal{B}}$  is a factor of  $\chi_{\mathcal{B}}$ .

For  $\mathcal{B}$  described by  $\frac{d}{dt}x = Ax, w = Cx$  with  $(A, C)$  observable,  $\chi_{\mathcal{B}}$  and  $\mu_{\mathcal{B}}$  are equal to the characteristic and minimal polynomial of  $A$ .

## Pole placement

### Theorem

Let  $\mathcal{P} \in \mathcal{L}^w$  be controllable. Then for all monic polynomials  $\pi \in \mathbb{R}[\xi]$ , there exists a regular controller  $\mathcal{C} \in \mathcal{L}^w$  such that

$$\chi_{\mathcal{P} \cap \mathcal{C}} = \pi.$$

## Pole placement

### Theorem

Let  $\mathcal{P} \in \mathcal{L}^w$  be controllable. Then for all monic polynomials  $\pi \in \mathbb{R}[\xi]$ , there exists a regular controller  $\mathcal{C} \in \mathcal{L}^w$  such that

$$\chi_{\mathcal{P} \cap \mathcal{C}} = \pi.$$

**Proof:** Let  $P \left( \frac{d}{dt} \right) w = 0$  be a minimal kernel representation of  $\mathcal{P}$ . The Smith form yields  $P = U \begin{bmatrix} 0_{p(\mathcal{P}) \times m(\mathcal{P})} & I_{p(\mathcal{P}) \times p(\mathcal{P})} \end{bmatrix} V$ , with  $U$  and  $V$  unimodular. Take for  $\mathcal{C}$  the system  $C \left( \frac{d}{dt} \right) w = 0$ , with  $C = \begin{bmatrix} \text{diag}(\pi, 1, \dots, 1) & 0_{m(\mathcal{P}) \times p(\mathcal{P})} \end{bmatrix} V$ .

## Pole placement

The above proof can be refined in numerous directions (see Exercise IV.5).

In particular, we obtain

### Theorem

Let  $\mathcal{P} \in \mathcal{L}^w$  be controllable. Then for all monic polynomials  $v \in \mathbb{R}[\xi]$ , there exists a regular controller  $\mathcal{C} \in \mathcal{L}^w$  such that

$$\mu_{\mathcal{P}n\mathcal{C}} = v.$$



## Stabilization

and

### Theorem

Let  $\mathcal{P} \in \mathcal{L}^w$  be stabilizable. Then there exists a regular controller  $\mathcal{C} \in \mathcal{L}^w$  such that the autonomous system

$\mathcal{P} \cap \mathcal{C}$  is stable.

# Recapitulation

## Summary

- ▶ **Complex systems consist of interconnections of subsystems.**

## Summary

- ▶ **Complex systems consist of interconnections of subsystems.**
- ▶ **Input/output thinking and signal flow graphs provide a very limited view of interconnected physical systems.**

## Summary

- ▶ **Complex systems consist of interconnections of subsystems.**
- ▶ **Input/output thinking and signal flow graphs provide a very limited view of interconnected physical systems.**
- ▶ **Modeling of interconnected systems proceeds by tearing, zooming, and linking.**

## Summary

- ▶ **Complex systems consist of interconnections of subsystems.**
- ▶ **Input/output thinking and signal flow graphs provide a very limited view of interconnected physical systems.**
- ▶ **Modeling of interconnected systems proceeds by tearing, zooming, and linking.**
- ▶ **A graph with leaves is a useful formalization of the interconnection architecture of an interconnected system.**

## Summary

- ▶ **Complex systems consist of interconnections of subsystems.**
- ▶ **Input/output thinking and signal flow graphs provide a very limited view of interconnected physical systems.**
- ▶ **Modeling of interconnected systems proceeds by tearing, zooming, and linking.**
- ▶ **A graph with leaves is a useful formalization of the interconnection architecture of an interconnected system.**
- ▶ **Control as interconnection is an effective way of thinking about control, with feedback control as a very useful special case.**

## Summary

- ▶ **Complex systems consist of interconnections of subsystems.**
- ▶ **Input/output thinking and signal flow graphs provide a very limited view of interconnected physical systems.**
- ▶ **Modeling of interconnected systems proceeds by tearing, zooming, and linking.**
- ▶ **A graph with leaves is a useful formalization of the interconnection architecture of an interconnected system.**
- ▶ **Control as interconnection is an effective way of thinking about control, with feedback control as a very useful special case.**
- ▶ **Controllable LTIDSs allow regular controllers that achieve an arbitrary characteristic polynomial for the controlled system. Stabilizable LTIDSs can be stabilized by regular controllers.**



**End of Lecture IV**